

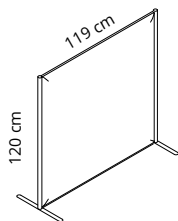

PRIJSLIJST CLIP

AKOESTIEKBOETIEK

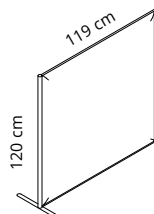
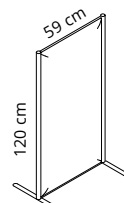
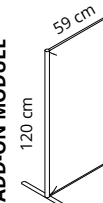

**SOUND ABSORBING
PANELS**
**MODULO BASE
STARTING MODULE**

**MODULO SEGUITO
ADD-ON MODULE**

**MODULO BASE
STARTING MODULE**

**MODULO SEGUITO
ADD-ON MODULE**

Colore Colour	Codice/Code Prezzo/Price	Codice/Code Prezzo/Price	Codice/Code Prezzo/Price	Codice/Code Prezzo/Price
Bianco White	0001 6CL1P-0001 € 860,00	6CL1PS-0001 € 760,00	6CL2P-0001 € 569,00	6CL2PS-0001 € 469,00
Bianco ghiaccio Cool white	8002 6CL1P-8002 € 860,00	6CL1PS-8002 € 760,00	6CL2P-8002 € 569,00	6CL2PS-8002 € 469,00
Grigio argento Silver grey	8004 6CL1P-8004 € 860,00	6CL1PS-8004 € 760,00	6CL2P-8004 € 569,00	6CL2PS-8004 € 469,00
Grigio scuro Dark grey	8007 6CL1P-8007 € 860,00	6CL1PS-8007 € 760,00	6CL2P-8007 € 569,00	6CL2PS-8007 € 469,00
Beige Beige	1008 6CL1P-1008 € 860,00	6CL1PS-1008 € 760,00	6CL2P-1008 € 569,00	6CL2PS-1008 € 469,00
Giallo Yellow	3008 6CL1P-3008 € 860,00	6CL1PS-3008 € 760,00	6CL2P-3008 € 569,00	6CL2PS-3008 € 469,00
Arancione Orange	4030 6CL1P-4030 € 860,00	6CL1PS-4030 € 760,00	6CL2P-4030 € 569,00	6CL2PS-4030 € 469,00
Rosso Red	4027 6CL1P-4027 € 860,00	6CL1PS-4027 € 760,00	6CL2P-4027 € 569,00	6CL2PS-4027 € 469,00
Verde chiaro Light green	7004 6CL1P-7004 € 860,00	6CL1PS-7004 € 760,00	6CL2P-7004 € 569,00	6CL2PS-7004 € 469,00
Azzurro Light blue	6046 6CL1P-6046 € 860,00	6CL1PS-6046 € 760,00	6CL2P-6046 € 569,00	6CL2PS-6046 € 469,00
Ottanio Teal	6075 6CL1P-6075 € 860,00	6CL1PS-6075 € 760,00	6CL2P-6075 € 569,00	6CL2PS-6075 € 469,00
Nero Black	8033 6CL1P-8033 € 860,00	6CL1PS-8033 € 760,00	6CL2P-8033 € 569,00	6CL2PS-8033 € 469,00

Paretina divisoria con montanti in alluminio verniciato e pannello con imbottitura interna in poliester a densità variabile Snowsound Technology. Rivestimento esterno in tessuto di poliester Trevira CS.
Basi piatte in acciaio verniciato.

Partition with epoxy coated aluminium uprights and panel with Snowsound Technology variable-density polyester interior padding. External covering in Trevira CS polyester fabric. Epoxy coated steel flat bases.

Cloison avec montants en aluminium peint époxy et panneau avec rembourrage intérieur en polyester à densité variable Snowsound Technology. Revêtement extérieur en tissu polyester Trevira CS. Bases plates en acier peint époxy.

Tabique con montantes de aluminio barnizado y panel con acolchado interior de poliéster de densidad variable Snowsound Technology. Revestimiento exterior en tejido de poliéster Trevira CS. Bases planas de acero barnizado.

Trennwand mit lackierten Aluminiumpfosten und Paneel mit Snowsound Technology-Polsterung mit variabler Dichte. Außenverkleidung aus Polyestergewebe Trevira CS. Flache Sockel aus beschichtetem Stahl.

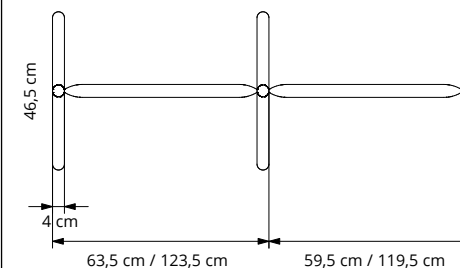



SOUND ABSORBING PANELS

MODULO BASE
STARTING MODULE

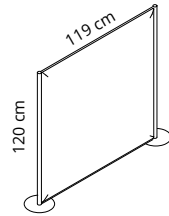

MODULO SEGUITO
ADD-ON MODULE

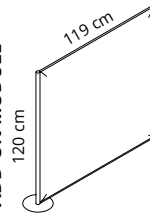

MODULO BASE
STARTING MODULE

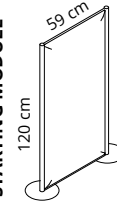

MODULO SEGUITO
ADD-ON MODULE



Colore Colour	Codice/Code Prezzo/Price	Codice/Code Prezzo/Price	Codice/Code Prezzo/Price	Codice/Code Prezzo/Price
Bianco White	0001 6CL1R-0001 € 920,00	6CL1RS-0001 € 820,00	6CL2R-0001 € 609,00	6CL2RS-0001 € 509,00
Bianco ghiaccio Cool white	8002 6CL1R-8002 € 920,00	6CL1RS-8002 € 820,00	6CL2R-8002 € 609,00	6CL2RS-8002 € 509,00
Grigio argento Silver grey	8004 6CL1R-8004 € 920,00	6CL1RS-8004 € 820,00	6CL2R-8004 € 609,00	6CL2RS-8004 € 509,00
Grigio scuro Dark grey	8007 6CL1R-8007 € 920,00	6CL1RS-8007 € 820,00	6CL2R-8007 € 609,00	6CL2RS-8007 € 509,00
Beige Beige	1008 6CL1R-1008 € 920,00	6CL1RS-1008 € 820,00	6CL2R-1008 € 609,00	6CL2RS-1008 € 509,00
Giallo Yellow	3008 6CL1R-3008 € 920,00	6CL1RS-3008 € 820,00	6CL2R-3008 € 609,00	6CL2RS-3008 € 509,00
Arancione Orange	4030 6CL1R-4030 € 920,00	6CL1RS-4030 € 820,00	6CL2R-4030 € 609,00	6CL2RS-4030 € 509,00
Rosso Red	4027 6CL1R-4027 € 920,00	6CL1RS-4027 € 820,00	6CL2R-4027 € 609,00	6CL2RS-4027 € 509,00
Verde chiaro Light green	7004 6CL1R-7004 € 920,00	6CL1RS-7004 € 820,00	6CL2R-7004 € 609,00	6CL2RS-7004 € 509,00
Azzurro Light blue	6046 6CL1R-6046 € 920,00	6CL1RS-6046 € 820,00	6CL2R-6046 € 609,00	6CL2RS-6046 € 509,00
Ottanio Teal	6075 6CL1R-6075 € 920,00	6CL1RS-6075 € 820,00	6CL2R-6075 € 609,00	6CL2RS-6075 € 509,00
Nero Black	8033 6CL1R-8033 € 920,00	6CL1RS-8033 € 820,00	6CL2R-8033 € 609,00	6CL2RS-8033 € 509,00

Paretina divisoria con montanti in alluminio verniciato e pannello con imbottitura interna in poliester a densità variabile Snowsound Technology. Rivestimento esterno in tessuto di poliester Trevira CS. Basi tonde in acciaio verniciato.

Partition with epoxy coated aluminium uprights and panel with Snowsound Technology variable-density polyester interior padding. External covering in Trevira CS polyester fabric. Epoxy coated steel round bases.

Cloison avec montants en aluminium peint époxy et panneau avec rembourrage intérieur en polyester à densité variable Snowsound Technology. Revêtement extérieur en tissu polyester Trevira CS. Bases rondes en acier peint époxy.

Tabique con montantes de aluminio barnizado y panel con acolchado interior de poliéster de densidad variable Snowsound Technology. Revestimiento exterior en tejido de poliéster Trevira CS. Bases redondas de acero barnizado.

Trennwand mit lackierten Aluminiumpfosten und Paneel mit Snowsound Technology-Polsterung mit variabler Dichte. Außenverkleidung aus Polyestergewebe Trevira CS. Runde Sockel aus beschichtetem Stahl.

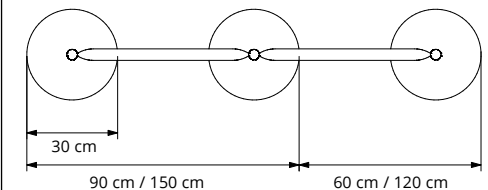



**SOUND ABSORBING
PANELS**

**MODULO BASE
STARTING MODULE**

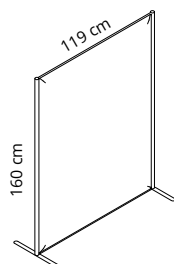

**MODULO SEGUITO
ADD-ON MODULE**

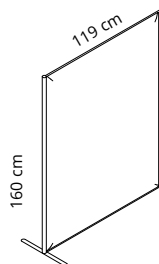

**MODULO BASE
STARTING MODULE**

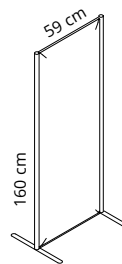

**MODULO SEGUITO
ADD-ON MODULE**



Colore Colour	Codice/Code Prezzo/Price	Codice/Code Prezzo/Price	Codice/Code Prezzo/Price	Codice/Code Prezzo/Price
Bianco White	0001 6CL3P-0001 € 980,00	6CL3PS-0001 € 880,00	6CL4P-0001 € 633,00	6CL4PS-0001 € 533,00
Bianco ghiaccio Cool white	8002 6CL3P-8002 € 980,00	6CL3PS-8002 € 880,00	6CL4P-8002 € 633,00	6CL4PS-8002 € 533,00
Grigio argento Silver grey	8004 6CL3P-8004 € 980,00	6CL3PS-8004 € 880,00	6CL4P-8004 € 633,00	6CL4PS-8004 € 533,00
Grigio scuro Dark grey	8007 6CL3P-8007 € 980,00	6CL3PS-8007 € 880,00	6CL4P-8007 € 633,00	6CL4PS-8007 € 533,00
Beige Beige	1008 6CL3P-1008 € 980,00	6CL3PS-1008 € 880,00	6CL4P-1008 € 633,00	6CL4PS-1008 € 533,00
Giallo Yellow	3008 6CL3P-3008 € 980,00	6CL3PS-3008 € 880,00	6CL4P-3008 € 633,00	6CL4PS-3008 € 533,00
Arancione Orange	4030 6CL3P-4030 € 980,00	6CL3PS-4030 € 880,00	6CL4P-4030 € 633,00	6CL4PS-4030 € 533,00
Rosso Red	4027 6CL3P-4027 € 980,00	6CL3PS-4027 € 880,00	6CL4P-4027 € 633,00	6CL4PS-4027 € 533,00
Verde chiaro Light green	7004 6CL3P-7004 € 980,00	6CL3PS-7004 € 880,00	6CL4P-7004 € 633,00	6CL4PS-7004 € 533,00
Azzurro Light blue	6046 6CL3P-6046 € 980,00	6CL3PS-6046 € 880,00	6CL4P-6046 € 633,00	6CL4PS-6046 € 533,00
Ottanio Teal	6075 6CL3P-6075 € 980,00	6CL3PS-6075 € 880,00	6CL4P-6075 € 633,00	6CL4PS-6075 € 533,00
Nero Black	8033 6CL3P-8033 € 980,00	6CL3PS-8033 € 880,00	6CL4P-8033 € 633,00	6CL4PS-8033 € 533,00

Paretina divisoria con montanti in alluminio verniciato e pannello con imbottitura interna in poliester a densità variabile Snowsound Technology. Rivestimento esterno in tessuto di poliester Trevira CS. Basi piatte in acciaio verniciato.

Partition with epoxy coated aluminium uprights and panel with Snowsound Technology variable-density polyester interior padding. External covering in Trevira CS polyester fabric. Epoxy coated steel flat bases.

Cloison avec montants en aluminium peint époxy et panneau avec rembourrage intérieur en polyester à densité variable Snowsound Technology. Revêtement extérieur en tissu polyester Trevira CS. Bases plates en acier peint époxy.

Tabique con montantes de aluminio barnizado y panel con acolchado interior de poliéster de densidad variable Snowsound Technology. Revestimiento exterior en tejido de poliéster Trevira CS. Bases planas de acero barnizado.

Trennwand mit lackierten Aluminiumpfosten und Paneel mit Snowsound Technology-Polsterung mit variabler Dichte. Außenverkleidung aus Polyestergewebe Trevira CS. Flache Sockel aus beschichtetem Stahl.

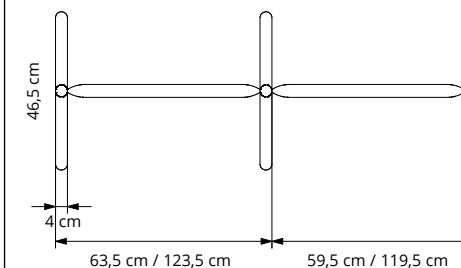



SOUND ABSORBING PANELS

MODULO BASE
STARTING MODULE

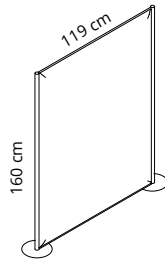

MODULO SEGUITO
ADD-ON MODULE

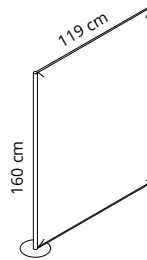

MODULO BASE
STARTING MODULE

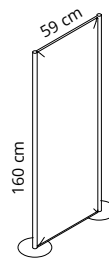

MODULO SEGUITO
ADD-ON MODULE



Colore Colour	Codice/Code Prezzo/Price	Codice/Code Prezzo/Price	Codice/Code Prezzo/Price	Codice/Code Prezzo/Price
Bianco White	0001 6CL3R-0001 € 1.050,00	6CL3RS-0001 € 950,00	6CL4R-0001 € 673,00	6CL4RS-0001 € 573,00
Bianco ghiaccio Cool white	8002 6CL3R-8002 € 1.050,00	6CL3RS-8002 € 950,00	6CL4R-8002 € 673,00	6CL4RS-8002 € 573,00
Grigio argento Silver grey	8004 6CL3R-8004 € 1.050,00	6CL3RS-8004 € 950,00	6CL4R-8004 € 673,00	6CL4RS-8004 € 573,00
Grigio scuro Dark grey	8007 6CL3R-8007 € 1.050,00	6CL3RS-8007 € 950,00	6CL4R-8007 € 673,00	6CL4RS-8007 € 573,00
Beige Beige	1008 6CL3R-1008 € 1.050,00	6CL3RS-1008 € 950,00	6CL4R-1008 € 673,00	6CL4RS-1008 € 573,00
Giallo Yellow	3008 6CL3R-3008 € 1.050,00	6CL3RS-3008 € 950,00	6CL4R-3008 € 673,00	6CL4RS-3008 € 573,00
Arancione Orange	4030 6CL3R-4030 € 1.050,00	6CL3RS-4030 € 950,00	6CL4R-4030 € 673,00	6CL4RS-4030 € 573,00
Rosso Red	4027 6CL3R-4027 € 1.050,00	6CL3RS-4027 € 950,00	6CL4R-4027 € 673,00	6CL4RS-4027 € 573,00
Verde chiaro Light green	7004 6CL3R-7004 € 1.050,00	6CL3RS-7004 € 950,00	6CL4R-7004 € 673,00	6CL4RS-7004 € 573,00
Azzurro Light blue	6046 6CL3R-6046 € 1.050,00	6CL3RS-6046 € 950,00	6CL4R-6046 € 673,00	6CL4RS-6046 € 573,00
Ottanio Teal	6075 6CL3R-6075 € 1.050,00	6CL3RS-6075 € 950,00	6CL4R-6075 € 673,00	6CL4RS-6075 € 573,00
Nero Black	8033 6CL3R-8033 € 1.050,00	6CL3RS-8033 € 950,00	6CL4R-8033 € 673,00	6CL4RS-8033 € 573,00

Paretina divisoria con montanti in alluminio verniciato e pannello con imbottitura interna in poliester a densità variabile Snowsound Technology. Rivestimento esterno in tessuto di poliester Trevira CS. Basi tonde in acciaio verniciato.

Partition with epoxy coated aluminium uprights and panel with Snowsound Technology variable-density polyester interior padding. External covering in Trevira CS polyester fabric. Epoxy coated steel round bases.

Cloison avec montants en aluminium peint époxy et panneau avec rembourrage intérieur en polyester à densité variable Snowsound Technology. Revêtement extérieur en tissu polyester Trevira CS. Bases rondes en acier peint époxy.

Tabique con montantes de aluminio barnizado y panel con acolchado interior de poliéster de densidad variable Snowsound Technology. Revestimiento exterior en tejido de poliéster Trevira CS. Bases redondas de acero barnizado.

Trennwand mit lackierten Aluminiumpfosten und Paneel mit Snowsound Technology-Polsterung mit variabler Dichte. Außenverkleidung aus Polyestergewebe Trevira CS. Runde Sockel aus beschichtetem Stahl.

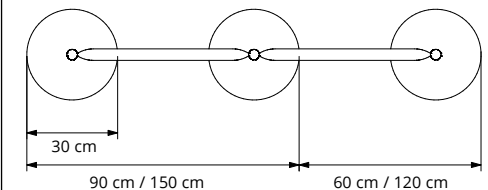

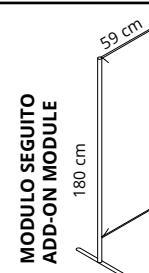
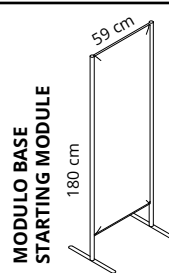
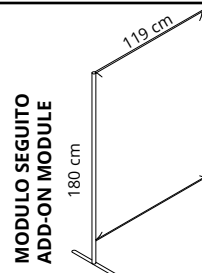
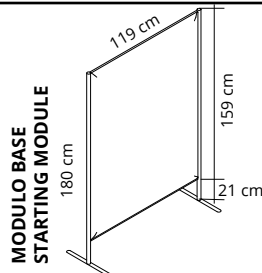
**SOUND ABSORBING
PANELS**

Colore Colour	Codice/Code Prezzo/Price	Codice/Code Prezzo/Price	Codice/Code Prezzo/Price	Codice/Code Prezzo/Price
Bianco White	0001 6CL5P-0001 € 990,00	6CL5PS-0001 € 890,00	6CL6P-0001 € 643,00	6CL6PS-0001 € 543,00
Bianco ghiaccio Cool white	8002 6CL5P-8002 € 990,00	6CL5PS-8002 € 890,00	6CL6P-8002 € 643,00	6CL6PS-8002 € 543,00
Grigio argento Silver grey	8004 6CL5P-8004 € 990,00	6CL5PS-8004 € 890,00	6CL6P-8004 € 643,00	6CL6PS-8004 € 543,00
Grigio scuro Dark grey	8007 6CL5P-8007 € 990,00	6CL5PS-8007 € 890,00	6CL6P-8007 € 643,00	6CL6PS-8007 € 543,00
Beige Beige	1008 6CL5P-1008 € 990,00	6CL5PS-1008 € 890,00	6CL6P-1008 € 643,00	6CL6PS-1008 € 543,00
Giallo Yellow	3008 6CL5P-3008 € 990,00	6CL5PS-3008 € 890,00	6CL6P-3008 € 643,00	6CL6PS-3008 € 543,00
Arancione Orange	4030 6CL5P-4030 € 990,00	6CL5PS-4030 € 890,00	6CL6P-4030 € 643,00	6CL6PS-4030 € 543,00
Rosso Red	4027 6CL5P-4027 € 990,00	6CL5PS-4027 € 890,00	6CL6P-4027 € 643,00	6CL6PS-4027 € 543,00
Verde chiaro Light green	7004 6CL5P-7004 € 990,00	6CL5PS-7004 € 890,00	6CL6P-7004 € 643,00	6CL6PS-7004 € 543,00
Azzurro Light blue	6046 6CL5P-6046 € 990,00	6CL5PS-6046 € 890,00	6CL6P-6046 € 643,00	6CL6PS-6046 € 543,00
Ottanio Teal	6075 6CL5P-6075 € 990,00	6CL5PS-6075 € 890,00	6CL6P-6075 € 643,00	6CL6PS-6075 € 543,00
Nero Black	8033 6CL5P-8033 € 990,00	6CL5PS-8033 € 890,00	6CL6P-8033 € 643,00	6CL6PS-8033 € 543,00

Paretina divisoria con montanti in alluminio verniciato e pannello con imbottitura interna in poliester a densità variabile Snowsound Technology. Rivestimento esterno in tessuto di poliester Trevira CS. Basi piatte in acciaio verniciato.

Partition with epoxy coated aluminium uprights and panel with Snowsound Technology variable-density polyester interior padding. External covering in Trevira CS polyester fabric. Epoxy coated steel flat bases.

Cloison avec montants en aluminium peint époxy et panneau avec rembourrage intérieur en polyester à densité variable Snowsound Technology. Revêtement extérieur en tissu polyester Trevira CS. Bases plates en acier peint époxy.

Tabique con montantes de aluminio barnizado y panel con acolchado interior de poliéster de densidad variable Snowsound Technology. Revestimiento exterior en tejido de poliéster Trevira CS. Bases planas de acero barnizado.

Trennwand mit lackierten Aluminiumpfosten und Paneel mit Snowsound Technology-Polsterung mit variabler Dichte. Außenverkleidung aus Polyestergewebe Trevira CS. Flache Sockel aus beschichtetem Stahl.

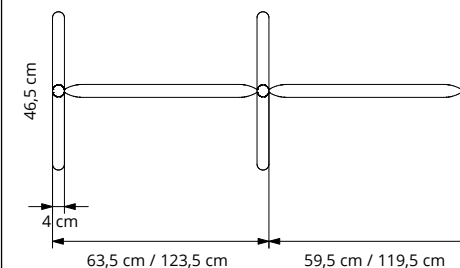



SOUND ABSORBING PANELS

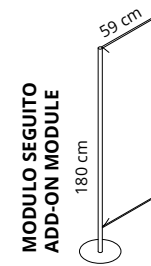
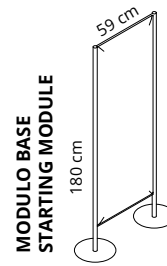
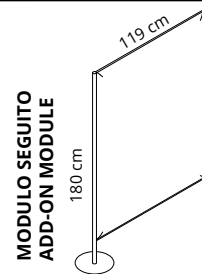
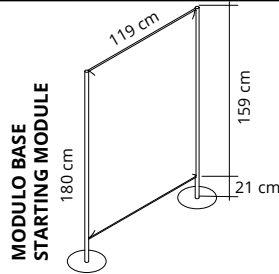

Colore Colour	Codice/Code Prezzo/Price	Codice/Code Prezzo/Price	Codice/Code Prezzo/Price	Codice/Code Prezzo/Price
Bianco White	0001 6CL5R-0001 € 1.060,00	6CL5RS-0001 € 960,00	6CL6R-0001 € 683,00	6CL6RS-0001 € 583,00
Bianco ghiaccio Cool white	8002 6CL5R-8002 € 1.060,00	6CL5RS-8002 € 960,00	6CL6R-8002 € 683,00	6CL6RS-8002 € 583,00
Grigio argento Silver grey	8004 6CL5R-8004 € 1.060,00	6CL5RS-8004 € 960,00	6CL6R-8004 € 683,00	6CL6RS-8004 € 583,00
Grigio scuro Dark grey	8007 6CL5R-8007 € 1.060,00	6CL5RS-8007 € 960,00	6CL6R-8007 € 683,00	6CL6RS-8007 € 583,00
Beige Beige	1008 6CL5R-1008 € 1.060,00	6CL5RS-1008 € 960,00	6CL6R-1008 € 683,00	6CL6RS-1008 € 583,00
Giallo Yellow	3008 6CL5R-3008 € 1.060,00	6CL5RS-3008 € 960,00	6CL6R-3008 € 683,00	6CL6RS-3008 € 583,00
Arancione Orange	4030 6CL5R-4030 € 1.060,00	6CL5RS-4030 € 960,00	6CL6R-4030 € 683,00	6CL6RS-4030 € 583,00
Rosso Red	4027 6CL5R-4027 € 1.060,00	6CL5RS-4027 € 960,00	6CL6R-4027 € 683,00	6CL6RS-4027 € 583,00
Verde chiaro Light green	7004 6CL5R-7004 € 1.060,00	6CL5RS-7004 € 960,00	6CL6R-7004 € 683,00	6CL6RS-7004 € 583,00
Azzurro Light blue	6046 6CL5R-6046 € 1.060,00	6CL5RS-6046 € 960,00	6CL6R-6046 € 683,00	6CL6RS-6046 € 583,00
Ottanio Teal	6075 6CL5R-6075 € 1.060,00	6CL5RS-6075 € 960,00	6CL6R-6075 € 683,00	6CL6RS-6075 € 583,00
Nero Black	8033 6CL5R-8033 € 1.060,00	6CL5RS-8033 € 960,00	6CL6R-8033 € 683,00	6CL6RS-8033 € 583,00

Paretina divisoria con montanti in alluminio verniciato e pannello con imbottitura interna in poliester a densità variabile Snowsound Technology. Rivestimento esterno in tessuto di poliester Trevira CS. Basi tonde in acciaio verniciato.

Partition with epoxy coated aluminium uprights and panel with Snowsound Technology variable-density polyester interior padding. External covering in Trevira CS polyester fabric. Epoxy coated steel round bases.

Cloison avec montants en aluminium peint époxy et panneau avec rembourrage intérieur en polyester à densité variable Snowsound Technology. Revêtement extérieur en tissu polyester Trevira CS. Bases rondes en acier peint époxy.

Tabique con montantes de aluminio barnizado y panel con acolchado interior de poliéster de densidad variable Snowsound Technology. Revestimiento exterior en tejido de poliéster Trevira CS. Bases redondas de acero barnizado.

Trennwand mit lackierten Aluminiumpfosten und Paneel mit Snowsound Technology-Polsterung mit variabler Dichte. Außenverkleidung aus Polyestergewebe Trevira CS. Runde Sockel aus beschichtetem Stahl.

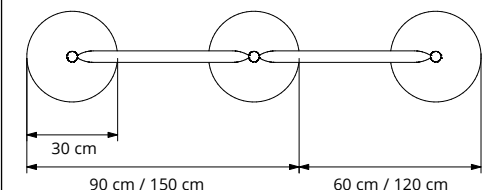

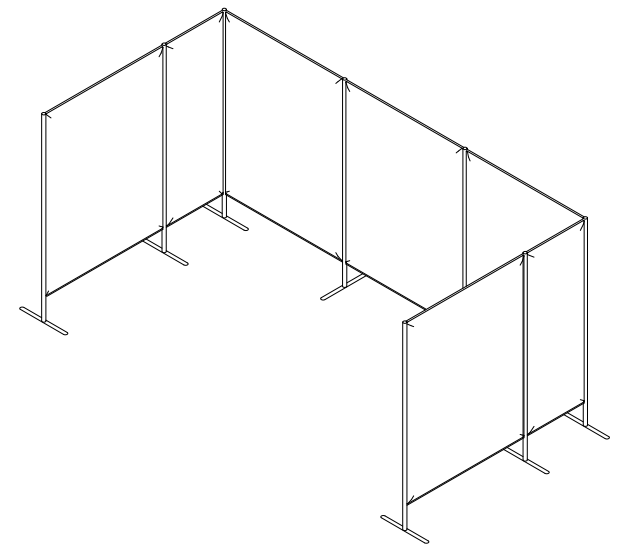
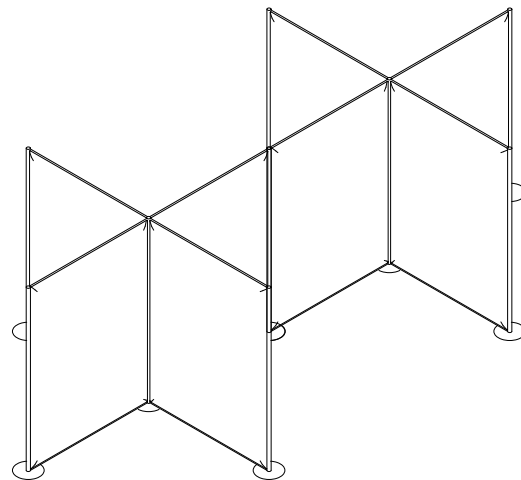
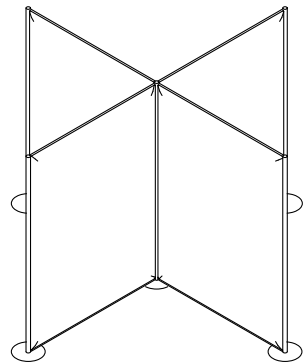
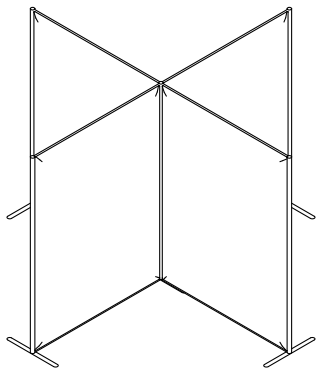

Snowsound Technology - Acoustic performance "A Class"

ANDAMENTO DEL COEFFICIENTE DI ASSORBIMENTO ACUSTICO "αs" PER TERZI D'OTTAVA
One-third octave sound absorption coefficient curve "αs"

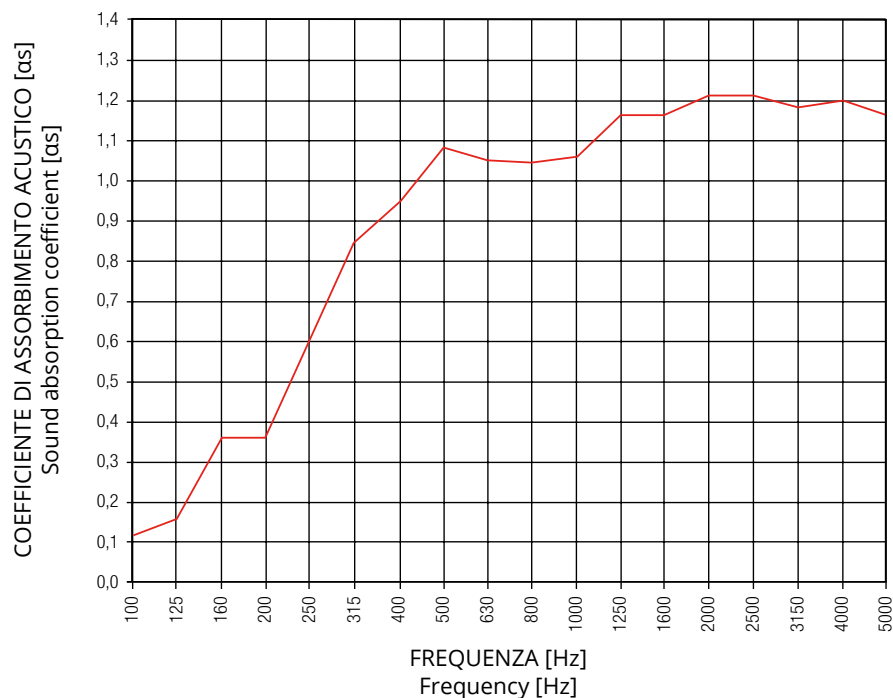

I_Misura dell'assorbimento acustico in camera riverberante UNI EN ISO 354 (pannelli Mitesco/Snowsound® installati accostati e con intercapedine d'aria posteriore di 200 mm).

EN_UNI EN ISO 354 measures sound-absorbing power in a reverberation room (Mitesco/Snowsound® panels installed side by side and with an 200 mm rear air space).

I_I pannelli Snowsound Technology sono stati testati in camera riverberante secondo la norma UNI EN ISO 354 ottenendo la "Classe di Assorbimento Acustico A" in accordo con la norma UNI EN ISO 11654.

EN_Snowsound Technology panels were tested in a reverberation room according to UNI EN ISO 354 standards obtaining "Class A sound absorption" to UNI EN ISO 11654 standards.

F_Les panneaux Snowsound Technology ont fait l'objet de tests en chambre réverbérante conformément à la norme UNI EN ISO 354, obtenant la "classe d'absorption acoustique A" selon la norme UNI EN ISO 11654.

E_Los paneles Snowsound Technology se probaron en cámara reverberante conformemente a la norma UNI EN ISO 354 consiguiendo la "Clase A de Absorción Acústica" en virtud de la norma UNI EN ISO 11654.

D_Die Snowsound Technology Paneele wurden gemäß der Norm UNI EN ISO 354 in einem Hallraum getestet. Sie erhielten gemäß der Norm UNI EN ISO 11654 die Klassifizierung "Schallabsorption A".



**Sound
absorbing
panel**



**Ascolta la
differenza
(video)**



**Listent to the
difference
(video)**



AKOESTIEKBOETIEK



Deze informatie is afkomstig van de website van AkoestiekBoetiek.nl.

Voor vragen, toelichting en meer informatie kunt u contact opnemen met:

AkoestiekBoetiek

Modem 20b

7741 MJ Coevorden

T +31 (0)85-077 3688

E info@akoestiekboetiek.nl

W www.akoestiekboetiek.nl