

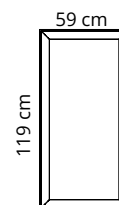

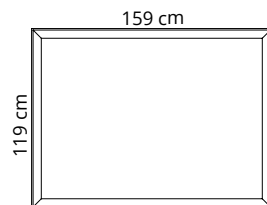

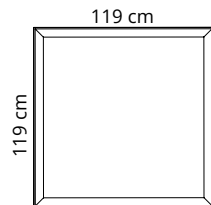





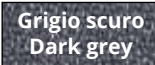

OVERSIZE DESK

AKOESTIEKBOETIEK



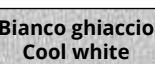
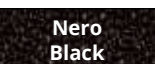

Colore Colour	Codice/Code Prezzo/Price	Codice/Code Prezzo/Price	Codice/Code Prezzo/Price
 Bianco White	0001	7S1212-0001	7S1216-0001
 Grigio argento Silver grey	8004	7S1212-8004	7S1216-8004
 Grigio scuro Dark grey	8007	7S1212-8007	7S1216-8007
 Beige Beige	1008	7S1212-1008	7S1216-1008
 Giallo Yellow	3008	7S1212-3008	7S1216-3008
 Arancione Orange	4030	7S1212-4030	7S1216-4030
 Rosso Red	4027	7S1212-4027	7S1216-4027
 Verde chiaro Light green	7004	7S1212-7004	7S1216-7004
 Azzurro Light blue	6046	7S1212-6046	7S1216-6046
 Ottanio Teal	6075	7S1212-6075	7S1216-6075
 Bianco ghiaccio Cool white	8002	7S1212-8002	7S1216-8002
 Nero Black	8033	7S1212-8033	7S1216-8033

Pannello con imbottitura interna in poliester a **densità variabile** Snowsound® Technology. Rivestimento esterno in tessuto di poliester Trevira CS®.

Panel with polyester internal padding with Snowsound® Technology **variable density**. Polyester covering in Trevira CS® fabric.

Panneau avec rembourrage interne en polyester à **densité variable** Snowsound® Technology. Revêtement externe en tissu de polyester Trevira CS®.

Panel con acolchado interior de poliéster de **densidad variable** Snowsound® Technology. Revestimiento exterior de tejido de poliéster Trevira CS®.

Panel mit Polyester-Füllmaterial von **unterschiedlicher Dichte** Snowsound® Technology. Polyester-Bezug aus Trevira CS®-Material.

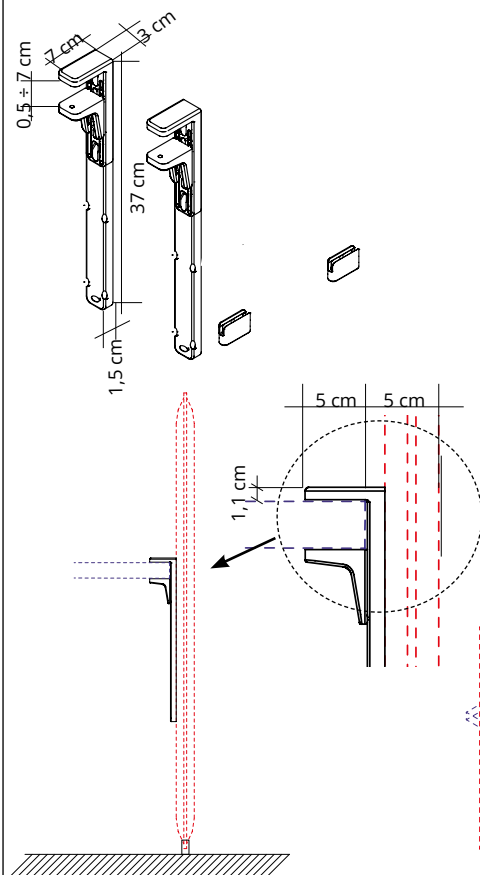

7S320-GA

Grigio argento
Silver grey
Gris argenté
Gris plata
Silbergrau

1 coppia / 1 pair
1 paire / 1 pare
1 Paar

7S320-BO

Bianco opaco
Mat white
Blanc mat
Blanco mate
Mattweiß

1 coppia / 1 pair
1 paire / 1 pare
1 Paar

Coppia attacchi con morsetto regolabile in alluminio e acciaio verniciato con polveri epossidiche per fissaggio al piano della scrivania. Completo di piedini in tecnopolimero e acciaio per l'appoggio a terra del pannello. **Per pannelli Oversize Desk pag. 118.**

Pair of brackets with adjustable clamp in powder-coated steel and aluminium for connection to the desk top. Complete with hi-tech polymer and steel small feet for the floor support of the panel. **For Oversize Desk panels page 118.**

Paire d'étriers avec étau réglable en acier et aluminium peint époxy pour fixation au bureau. Avec vérens en technopolymère et acier pour l'appui au sol du panneau. **Pour panneaux Oversize Desk page 118.**

Par de abrazaderas con sujetador ajustable en acero y aluminio recubierto epoxi para fijación al plan del escritorio. Completo con patas en tecnopolímero y acero para el apoyo en el suelo del panel. **Para panels Oversize Desk pag. 118.**

1 Paar Halterungen aus pulverbeschichtetem Stahl und Aluminium mit einstellbare Klemmen zur Befestigung an der Tischplatte. Mit Technopolymer- und Stahl-Füßchen ausgestattet, damit das Paneel auch auf den Boden gestellt werden kann. **Für Oversize Desk Paneele, Seite 118.**

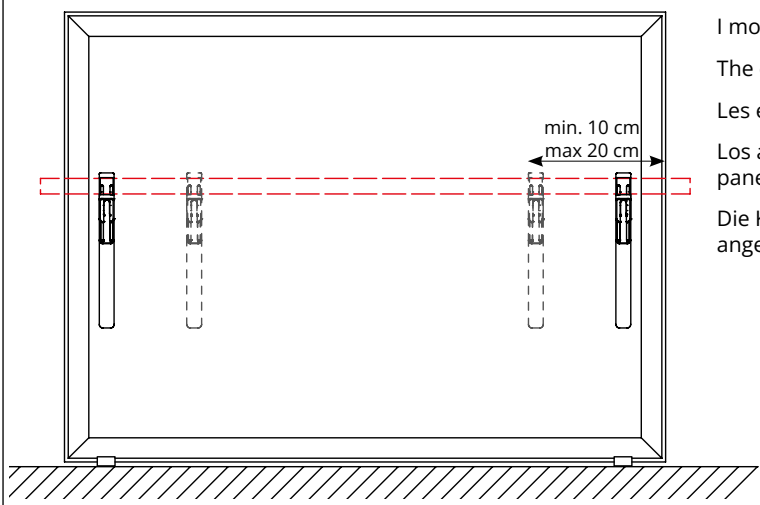

I morsetti possono essere applicati lungo il pannello.

The clamps can be positioned along the panel.

Les étriers peuvent être appliqués le long du panneau.

Los abrazaderas pueden ser posicionados a lo largo del panel.

Die Klemmen können beliebig entlang des Paneels angebracht werden.





AKOESTIEKBOETIEK



Deze informatie is afkomstig van de website van AkoestiekBoetiek.nl.

Voor vragen, toelichting en meer informatie kunt u contact opnemen met:

AkoestiekBoetiek

Modem 20b

7741 MJ Coevorden

T +31 (0)85-077 3688

E info@akoestiekboetiek.nl

W www.akoestiekboetiek.nl