



MONTAGE CLASP DIVIDER

AKOESTIEKBOETIEK



MOD. 533 / L0



8 002447 286056

Caimi
BREVETTI

CLASP DIVIDER

Design: studio A+B
Dominioni Quaquaro

* (xx = variante colore, colour alternative, variante couleur, variante color, Farbe Variante)

7CLD60-CL

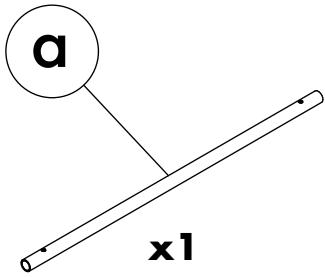

7CLD120-CL

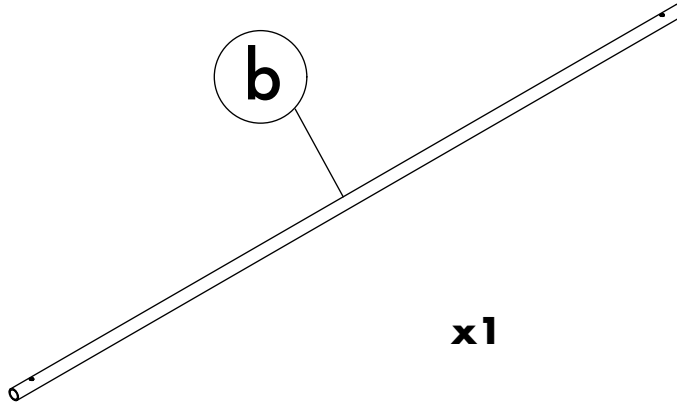

7CLDT200-xx*

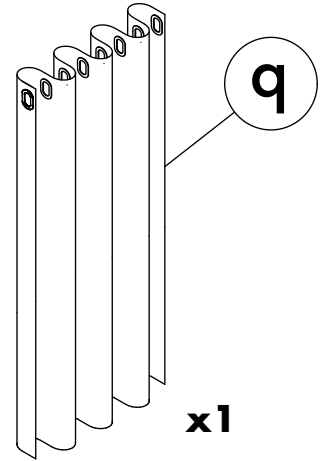

7CLDF-CL

7CLDF/S-CL

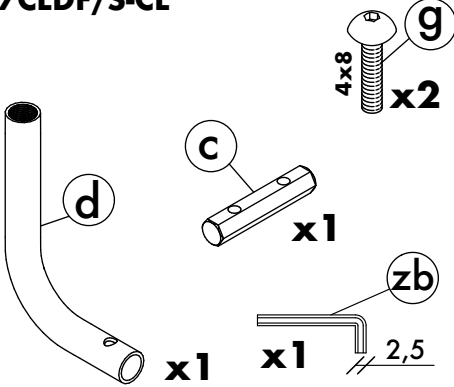

7SRM1013-C

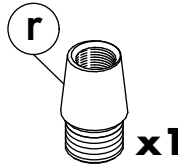

7SRM10-C

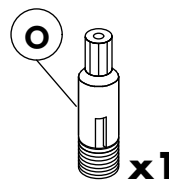

7S401

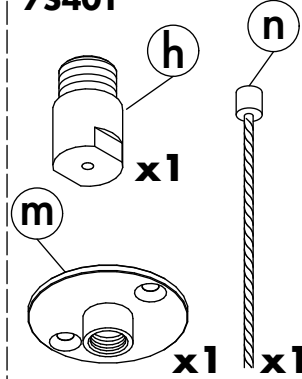

**7SM6-C
OPTIONAL**

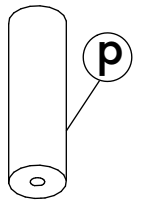

7CLDA-CL

7CLDA/S-CL

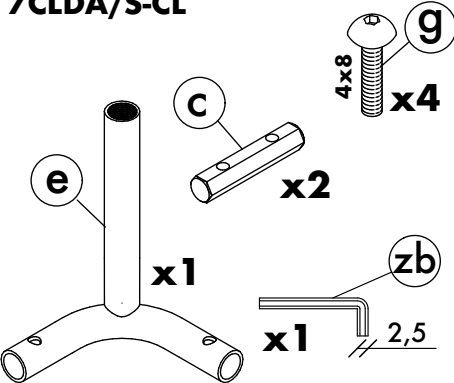

7SRM1013-C

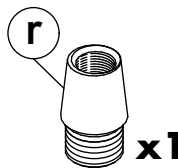

7SRM10-C

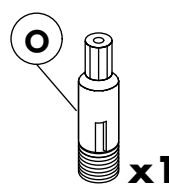

7S401

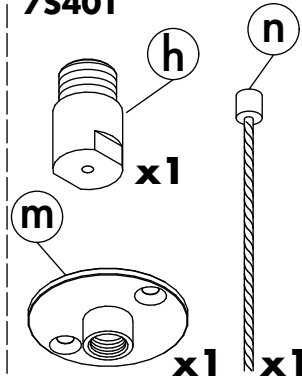

**7SM6-C
OPTIONAL**

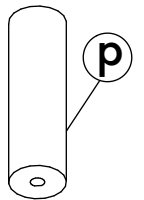

7CLDI-CL

7CLDI/S-CL

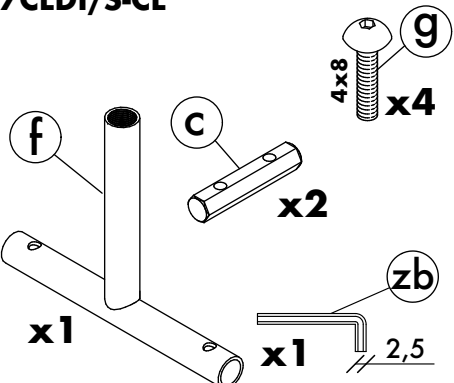

7SRM1013-C

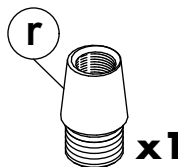

7SRM10-C

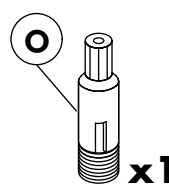

7S401

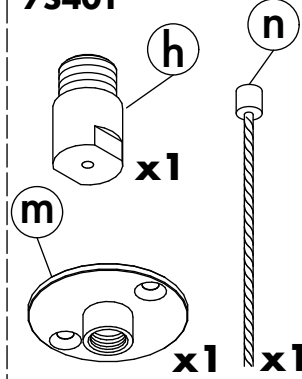

**7SM6-C
OPTIONAL**

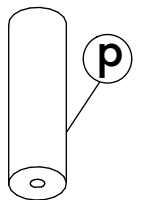

7CLD60-CL

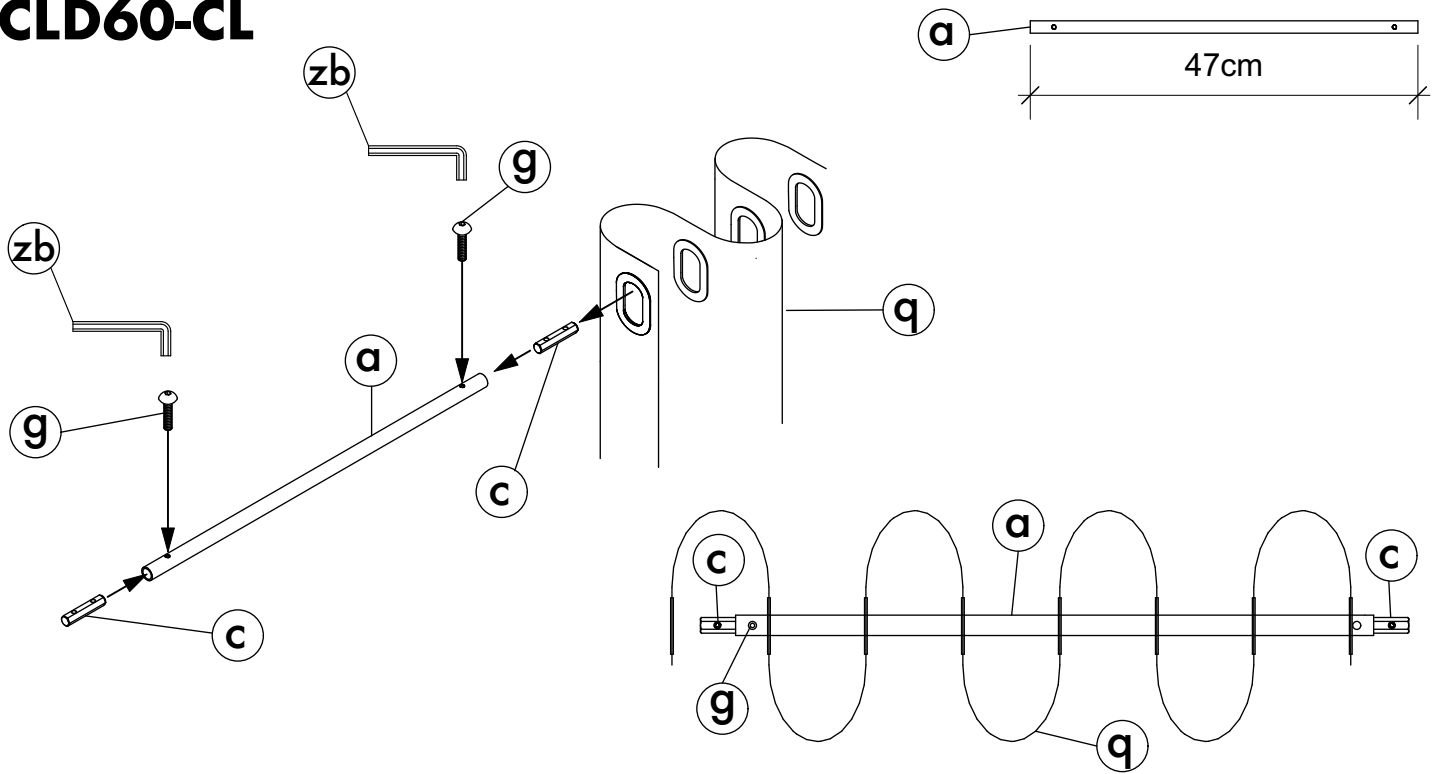

7CLD120-CL

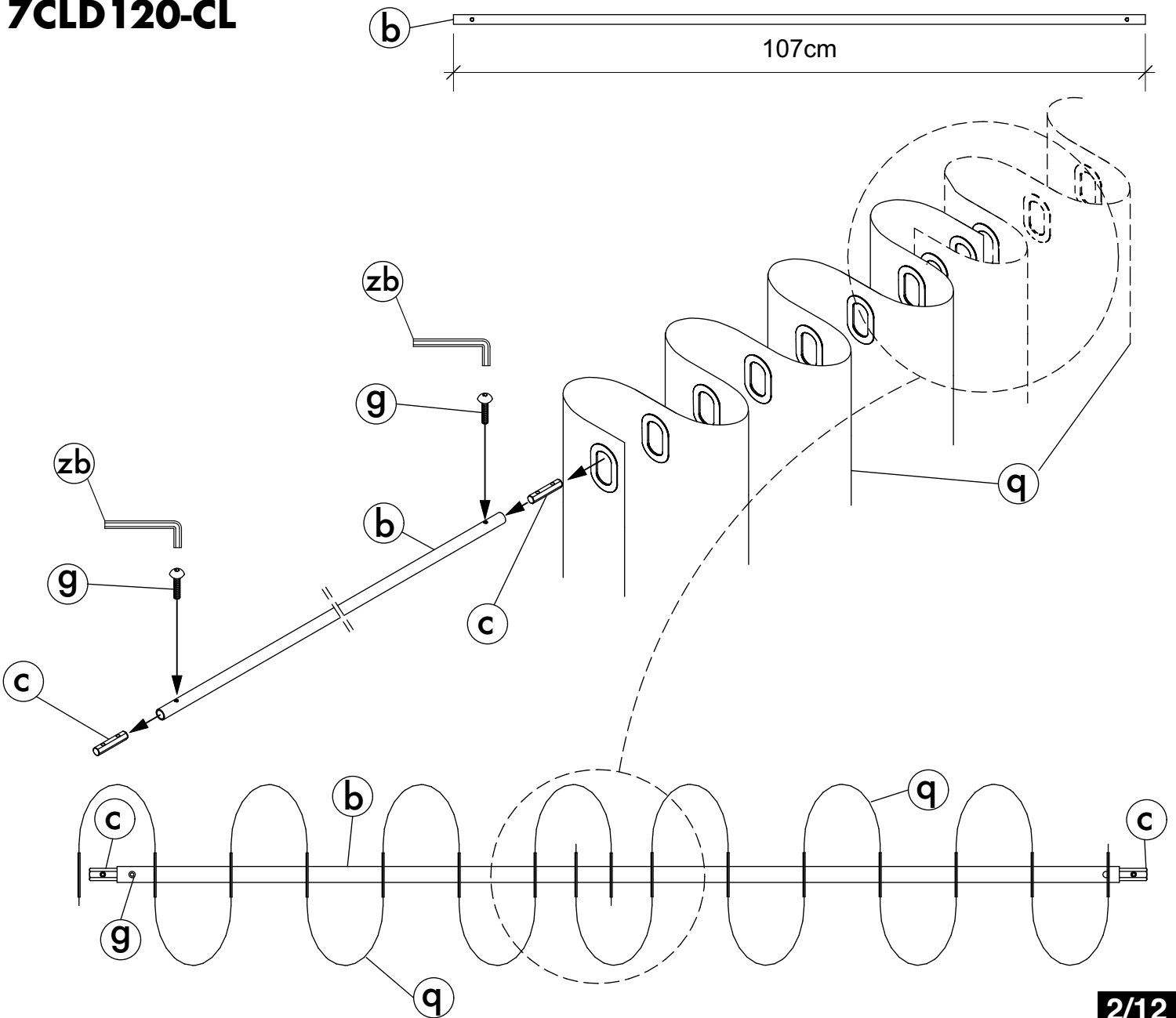

7CLDF/S-CL

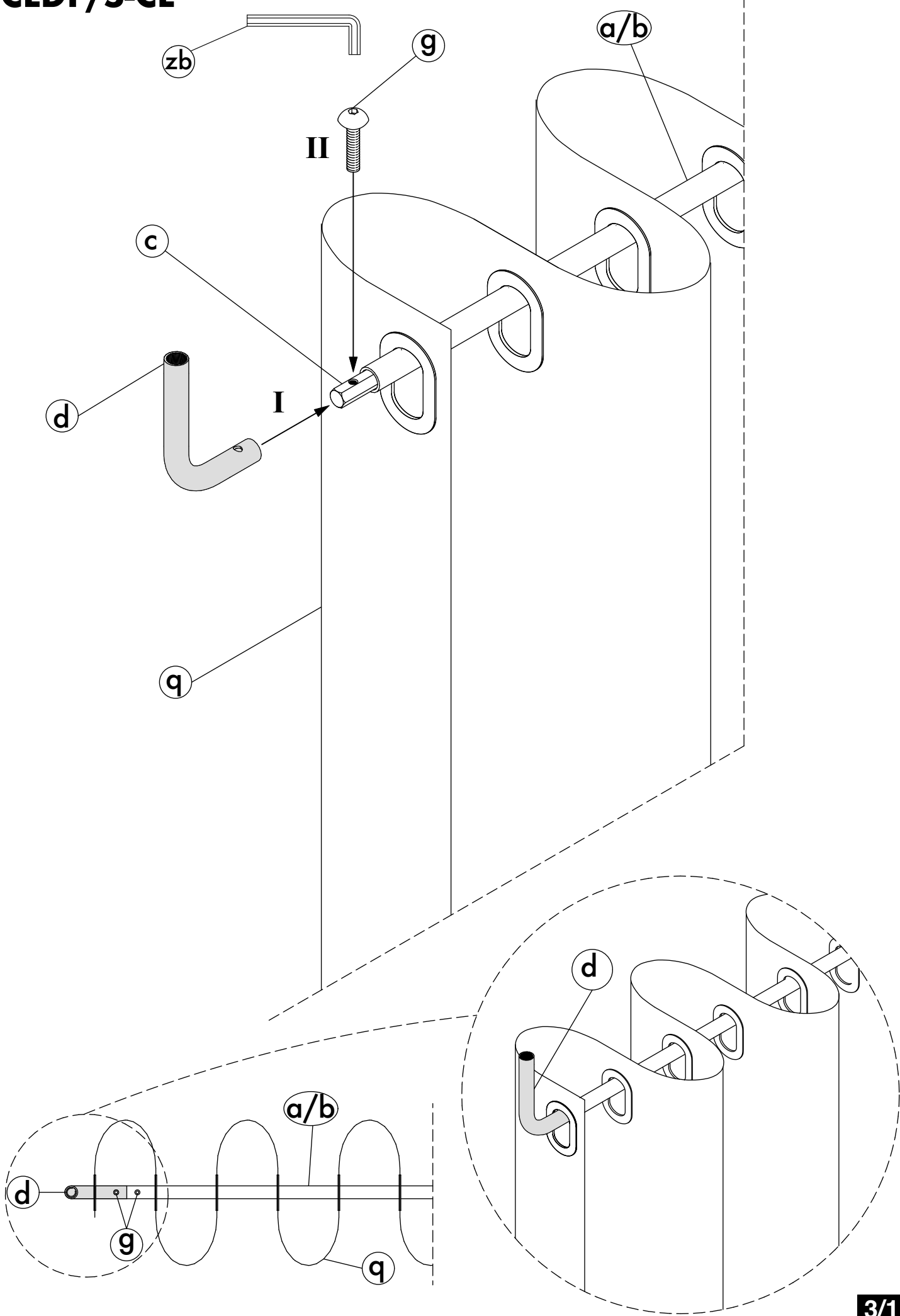

7CLDA/S-CL

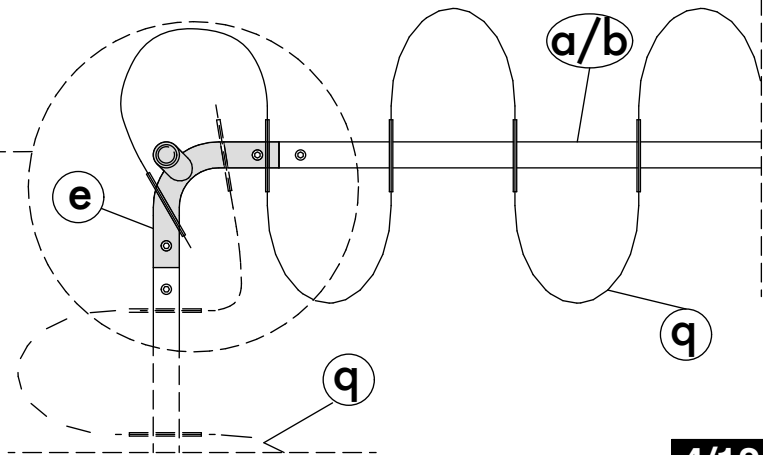
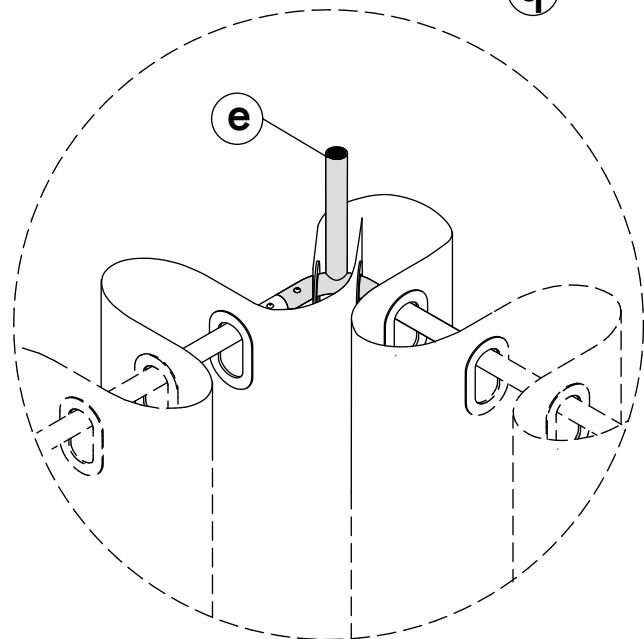
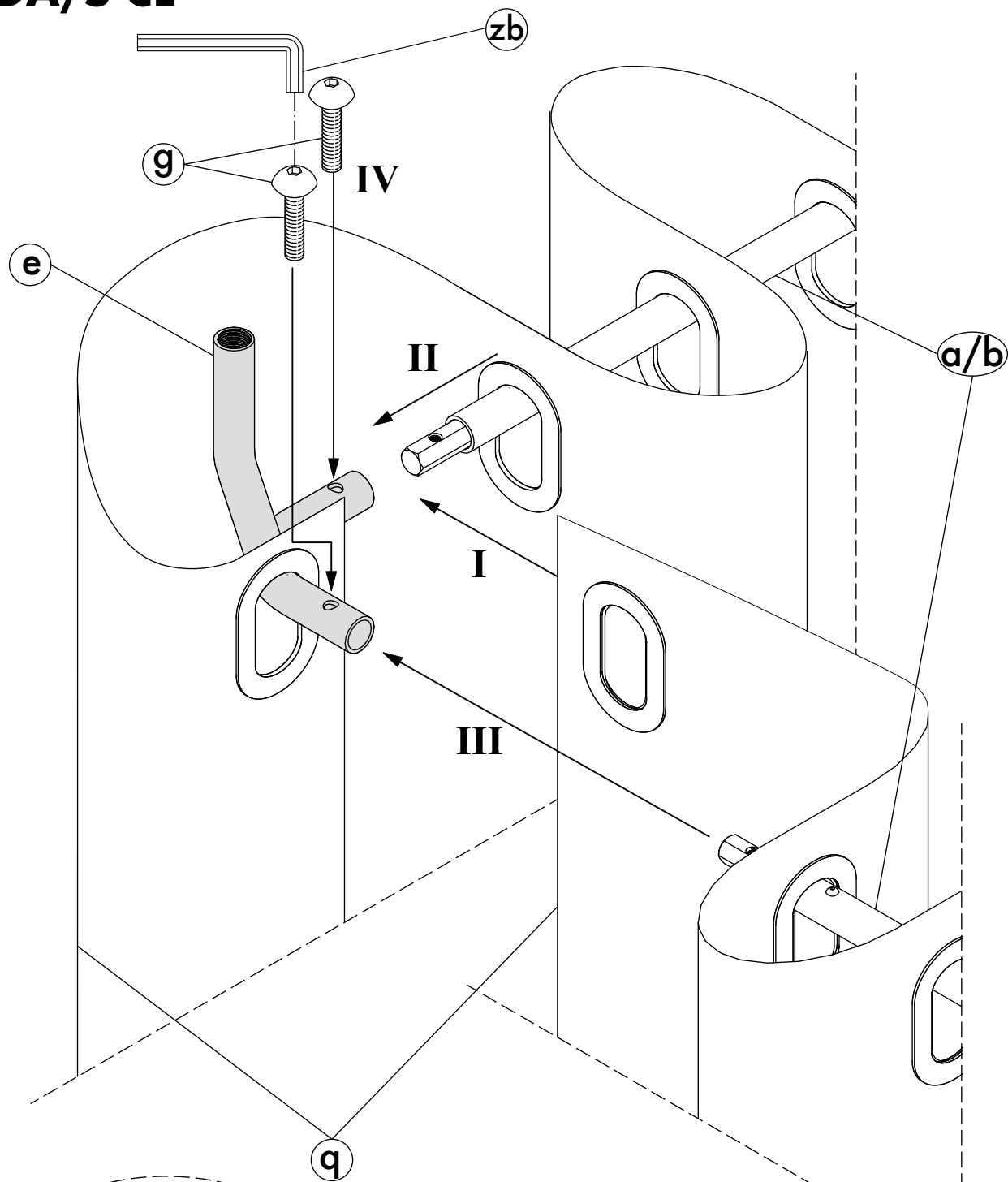

7CLDI/S-CL

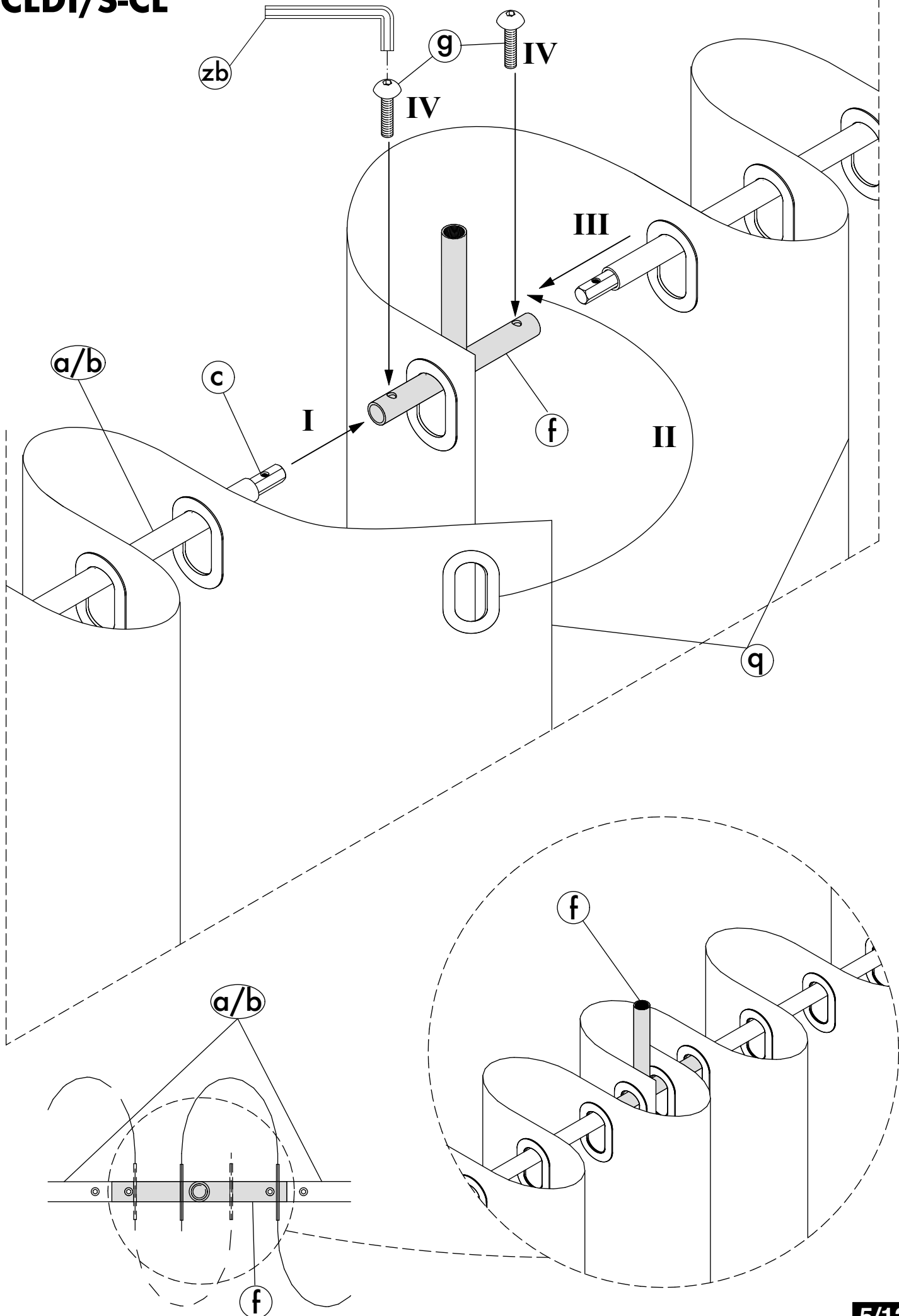

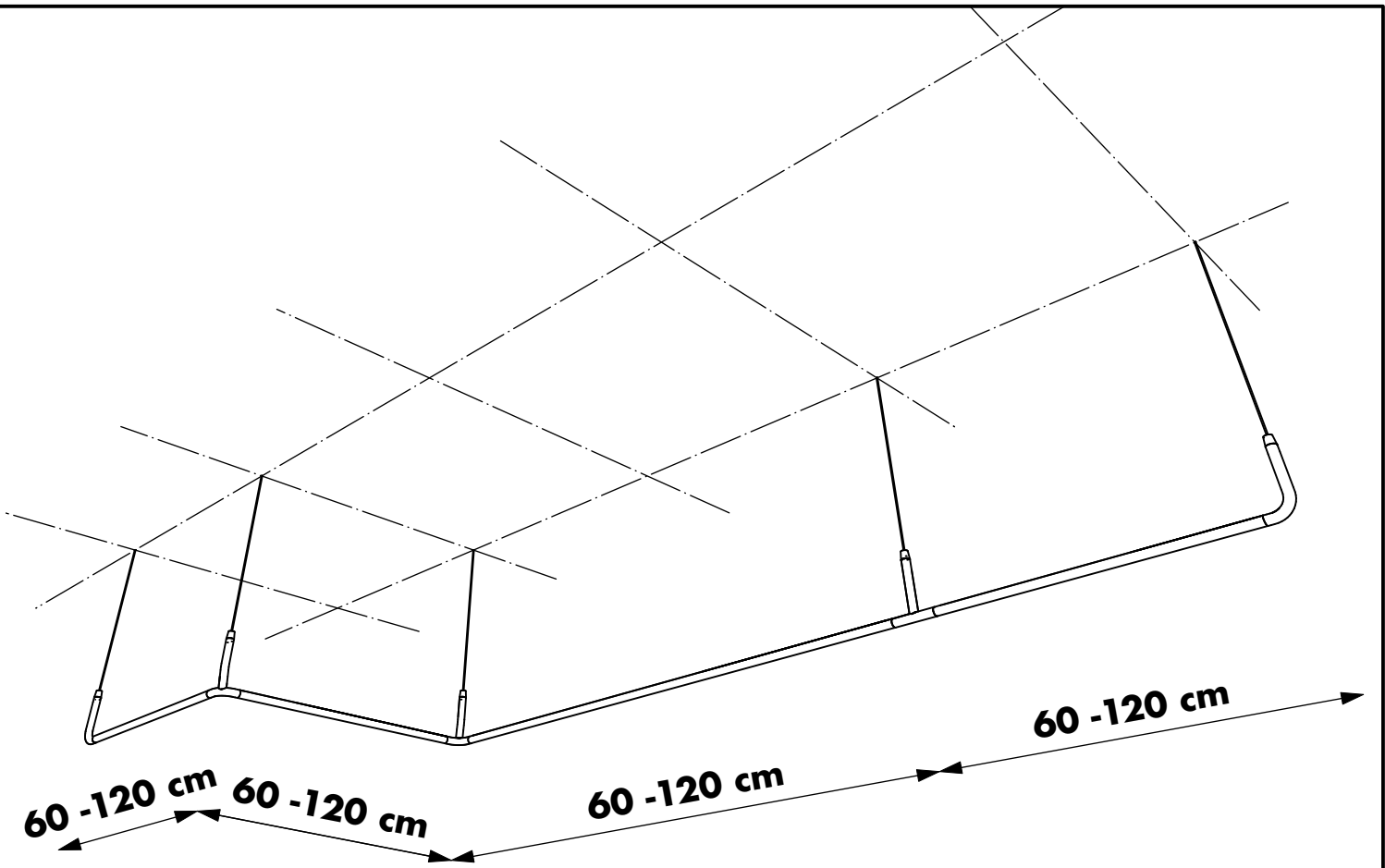

A

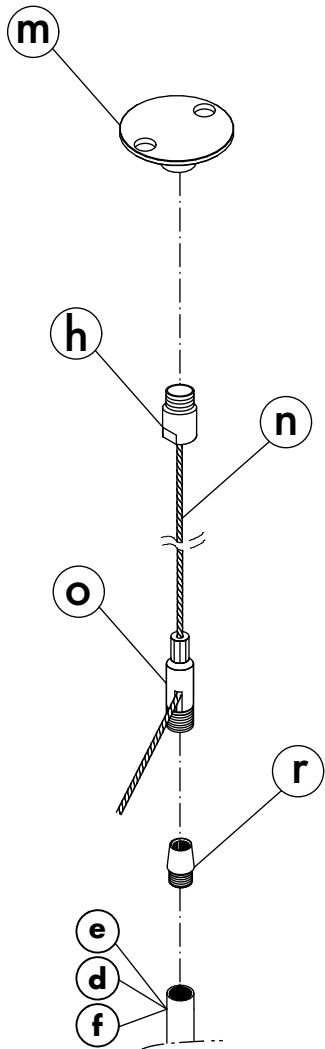

B

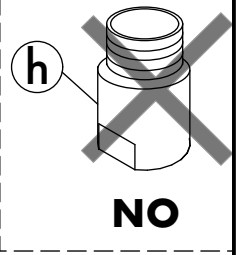
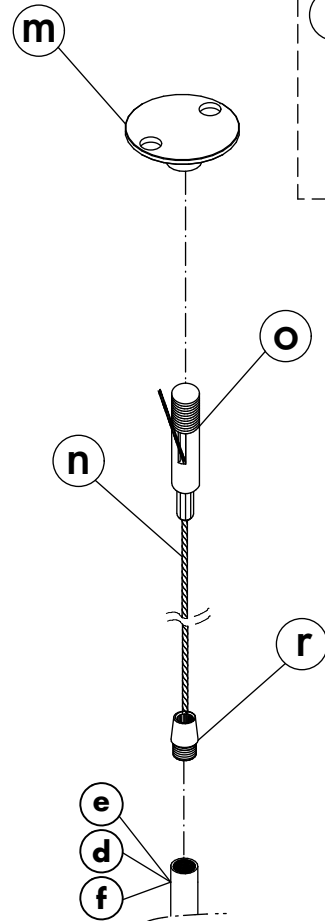

A-1

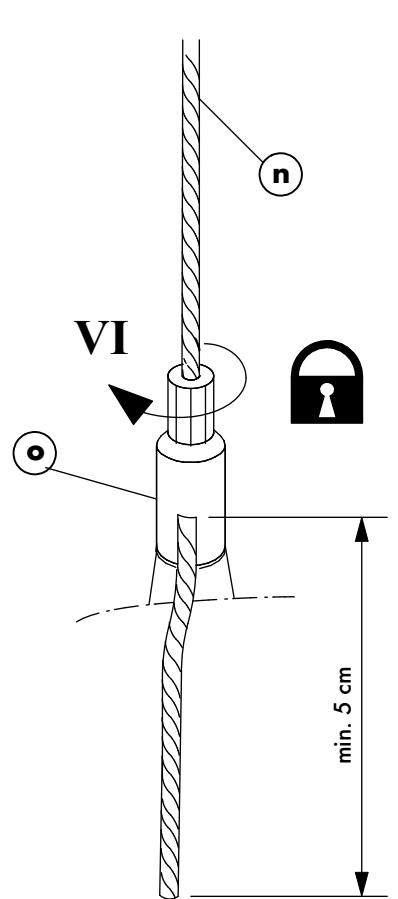
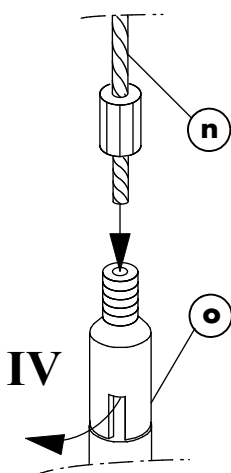
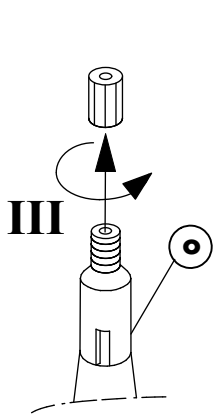
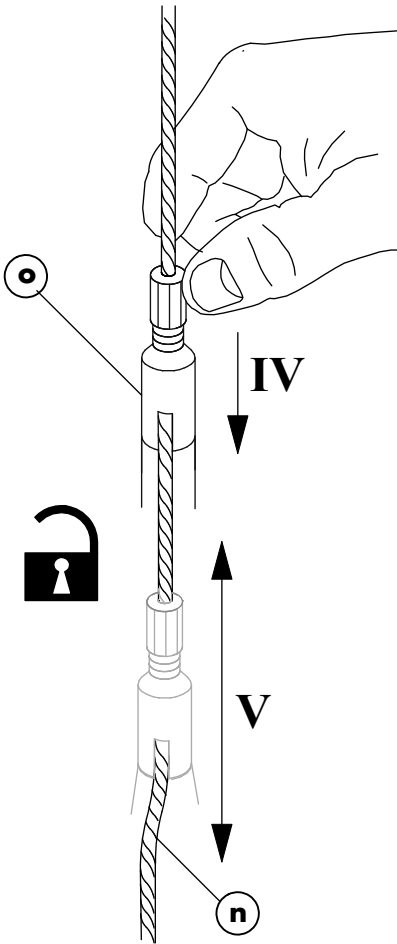
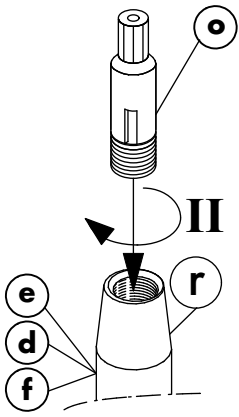
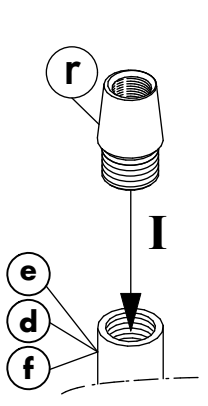
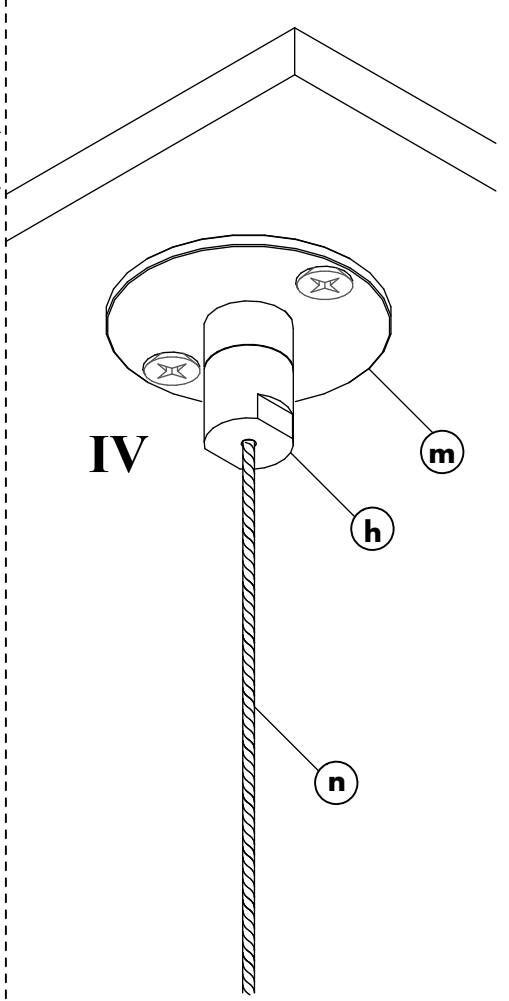
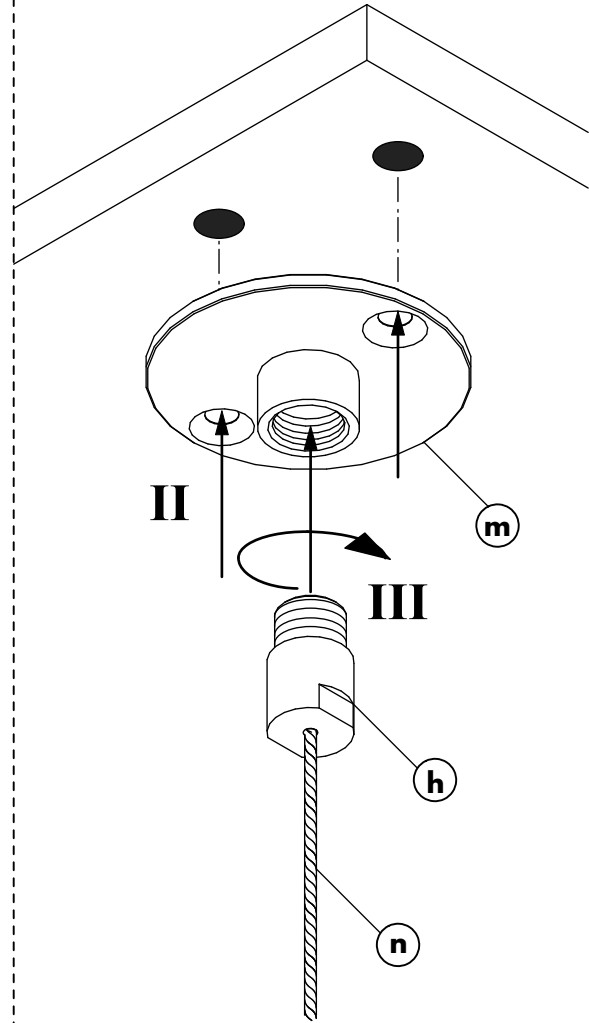
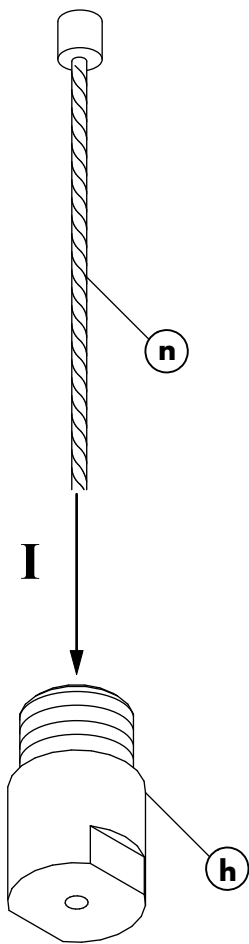

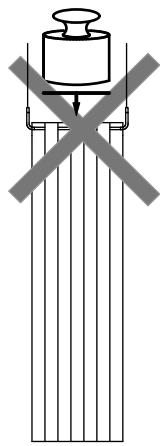

NO

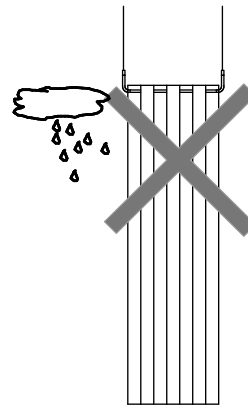

NO

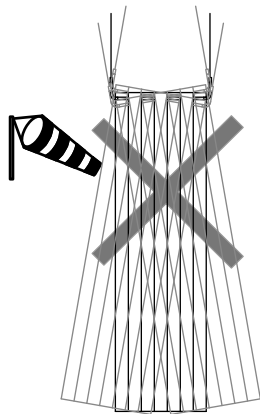

NO

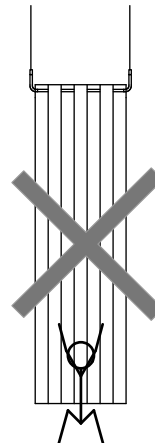

NO

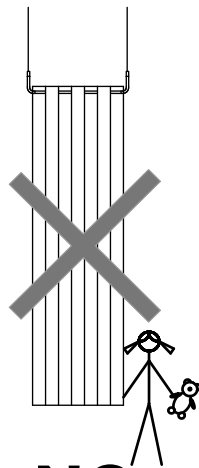

NO

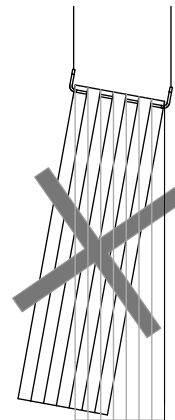

NO

- tenere lontano da fonti di calore
- keep away from heat sources
- tenir loin de sources de chaleur
- mantener alejado de fuentes de calor
- Von Wärmequellen fernhalten

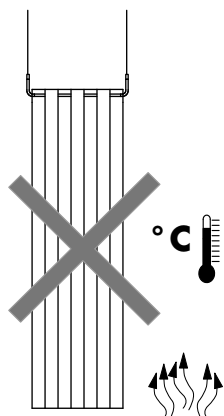

NO

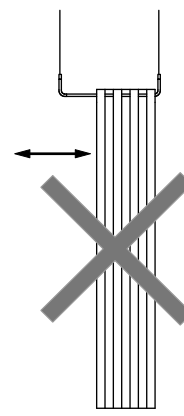

NO

AVVERTENZE!

ISTRUZIONI E INFORMAZIONI PER LA SICUREZZA

prima di procedere al montaggio ed all'installazione del prodotto leggere attentamente le avvertenze di seguito riportate, prestando particolare attenzione ai disegni esplicativi riportati nelle istruzioni per il montaggio. Consultare queste avvertenze ad ogni successivo montaggio e/o installazione del prodotto.

1. Il montaggio e l'installazione del prodotto deve essere effettuato esclusivamente da personale tecnico competente. **Attenzione:** ultimato il montaggio verificare sempre che la struttura realizzata sia idonea al tipo di utenza e/o di utilizzo a cui è destinata. I prodotti non sono comunque idonei all'uso da parte di bambini.
2. Prima di procedere all'installazione è necessario verificare la portanza della superficie su cui verrà collocato il prodotto, di conseguenza utilizzare dispositivi di fissaggio adeguati al tipo di superficie in grado di resistere alle forze generate. **Attenzione:** la superficie deve comunque essere orizzontale, piana, rigida e indeformabile.
3. **Attenzione:** in caso di dubbi sulle modalità di installazione e/o sulla portanza della superficie su cui verrà collocato il prodotto non procedere alla installazione del prodotto.
4. Snowsound-Fiber è lavabile a 30° e stirabile a bassa temperatura (max 110°)
5. Non utilizzare detersivi **per pulire le parti non in tessuto.**
6. Per ulteriori informazioni sulle modalità di installazione del prodotto contattare il rivenditore. Per i casi non contemplati contattare il rivenditore.
7. Accertarsi periodicamente che i sistemi meccanici di serraggio siano opportunamente fissati.

NOTE!

SAFETY INSTRUCTIONS AND INFORMATION

Prior to assembling and installing the unit please read the following notes carefully. Pay particular attention to the drawings in the assembly instructions. Please consult these notes every time the product is assembled and/or installed.

1. The product must only be assembled and installed by competent fitters. **Warning:** once the product has been assembled always check that the structure is suitable for the type of application and/or use to which it will be put. These products are not suitable for use by children.
2. Prior to installation check the load bearing capacity of the surface on which the product is to be fitted, use suitable fixtures according to the type of surface which must be able to withstand the forces generated. **Warning:** the surface must be horizontal, flat, rigid and non-deformable
3. **Warning:** if you have any doubts concerning how to install the product and/or the load bearing capacity of the surface on which it will be fitted, do not fit it. XX
4. Snowsound-Fiber is machine washable at 30°C and can be ironed at low temperature (max 110°)
5. **Do not use detergents to clean the parts that are not in textile fabric.**
6. For further information on how to install the product, please contact your dealer. For any use different from the ones here shown please contact the dealer.
7. Periodically check that the mechanical tightening systems are properly fixed.

MISES EN GARDE!

INSTRUCTIONS ET INFORMATIONS DE SÉCURITÉ

Avant de procéder au montage et à l'installation du produit, lire attentivement les mises en garde ci-dessous présentées, en faisant particulièrement attention aux dessins explicatifs rapportés dans les instructions de montage. Consulter ces mises en garde lors de chaque montage successif et/ou installation du produit.

1. Le montage et l'installation du produit doivent exclusivement être effectués par un personnel technique compétent. **Attention:** au terme du montage, toujours vérifier si la structure réalisée est appropriée au type d'usagers et/ou d'utilisation auxquels elle est destinée. Les produits ne sont pas destinés aux enfants.
2. Avant de procéder à l'installation, il est nécessaire de vérifier la capacité de charge de la surface sur laquelle le produit sera installé : en conséquence, utiliser les dispositifs de fixation adaptés au type de surface et qui peuvent résister aux forces produites. **Attention :** la surface doit être horizontale, plane, rigide et indeformable.
3. **Attention:** en cas de doute sur les modalités d'installation et/ou sur la capacité de charge de la surface sur laquelle le produit sera installé, ne pas monter le produit.
4. Snowsound-Fiber est lavable à 30° et se repasse à basse température (110° max)
5. **Ne pas utiliser de détergents pour nettoyer les pièces qui ne sont pas en tissu.**
6. Pour toute information complémentaire sur les modalités d'installation, contacter le revendeur. Pour emploi différent par rapport à ceux indiqués ici nous vous prions de contacter le revendeur.
7. Vérifier périodiquement que les systèmes mécaniques de serrage soient opportunément fixés.

¡ADVERTENCIAS!

INSTRUCCIONES E INFORMACIÓN DE SEGURIDAD

Antes de realizar el montaje y la instalación del producto leer atentamente las advertencias que se indican a continuación, prestando especial atención a los dibujos y a las instrucciones para el montaje. Consultar estas advertencias cada vez que se monte y/o instale el producto .

1. El montaje y la instalación del producto debe efectuarlo exclusivamente personal técnico competente. **Atención:** una vez acabado el montaje, hay que comprobar siempre que la estructura realizada sea apta para el tipo de servicio y/o uso al que se va a destinar. Los productos no son aptos para niños.
2. Antes de realizar la instalación es necesario controlar la capacidad de carga de la superficie en la que se colocará el producto : por consiguiente, hay que utilizar dispositivos de fijación adecuados para el tipo de superficie capaces de resistir las fuerzas generadas. **Atención:** la superficie debe en cualquier caso ser horizontal, plana, rígida e indeformable.
3. **Atención:** en caso de duda sobre las modalidades de instalación y/o sobre la capacidad de carga de la superficie en la que se vaya a colocar el producto, éste no deberá instalarse.
4. Snowsound-Fiber es lavable a 30° y se puede planchar a bajas temperaturas (max 110°)
5. **No utilizar detergentes para las partes que no son tejidos.**
6. Para más información sobre las modalidades de instalación del producto, ponerse en contacto con el vendedor. Para cualquier otra utilización por favor consulte con su distribuidor.
7. Verificar periódicamente que los sistemas mecánicos de cierres sean correctamente fijados.

WICHTIG!

SICHERHEITSHINWEISE UND INFORMATIONEN

Vor der Montage und der Aufstellung des Produktes folgende Anleitungen sorgfältig lesen und dabei die Einbauzeichnungen, die in den Montageanleitungen zu finden sind genau beachten. Die validen Angaben bezüglich der Montage und/oder Aufstellung des Produktes nachsehen.

1. Die Montage und die Aufstellung des Produktes dürfen ausschließlich von erfahrenem Fachpersonal ausgeführt werden. **Vorsicht:** sich nach der Montage immer vergewissern, dass die aufgestellte Struktur ihren Verwendungszwecken und/oder dem Benutzerkreis entspricht. Est ist aber dabei nicht zu vergessen, daß der Gebrauch dieser Produkte Kindern untersagt ist.
2. Vor jeglicher Montage die Oberfläche, an der das Produkt montiert werden soll, auf ihre Tragfähigkeit prüfen und passende Befestigungsmittel welche die erzeugten Kräfte aushalten können je nach Art der Oberfläche benutzen. **Vorsicht:** die Bodenfläche immer waagrecht, flach, steif und unverformbar sein.
3. Wichtig: bestehen Zweifel über die Einbaumodalitäten und /oder über die Tragfähigkeit der betroffenen Oberfläche, Produkt nicht aufstellen.
4. Snowsound-Fiber kann auf 30°C gewaschen und bei niedriger Temperatur (max 110°C) gebügelt werden
5. Verwenden Sie keine Reinigungsmittel, **um die Teile die Nicht auf Stoff sind, zu reinigen.**
6. Für weitere Angaben über die Aufstellungsmodalitäten wenden Sie sich bitte an Ihren Wiederverkäufer. Für alle Anlagen, die nicht aufgeführt sind, kontaktieren Sie bitte vor dem Einbau den Fachhandelspartner.
7. Kontrollieren Sie periodisch die mechanische Befestigung.

SNOWSOUND-FIBER



MAX 110°C

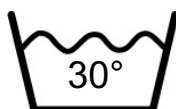

MAX 30°C





A KOESTIEKBOETIEK



Deze informatie is afkomstig van de website van AkoestiekBoetiek.nl.

Voor vragen, toelichting en meer informatie kunt u contact opnemen met:

AkoestiekBoetiek

Modem 20b

7741 MJ Coevorden

T +31 (0)85-077 3688

E info@akoestiekboetiek.nl

W www.akoestiekboetiek.nl