

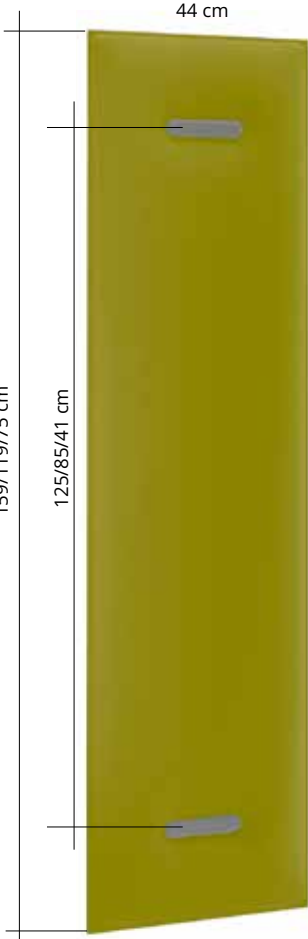









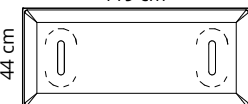
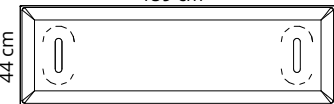





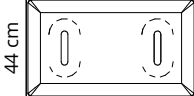
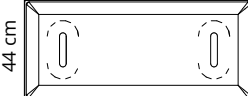

MITESCO WALL

AKOESTIEKBOETIEK



	Copertura grigia Grey cover Couverture gris Cobertura gris Graue Abdeckung	Colore Colour		75 cm	119 cm	159 cm
				44 cm	44 cm	44 cm
				Codice/Code Prezzo/Price	Codice/Code Prezzo/Price	Codice/Code Prezzo/Price
	 Bianco White Blanc	0001		7M1008-0001	7M1012-0001	7M1016-0001
	 Grigio argento Silver grey Gris argenté	8004		7M1008-8004	7M1012-8004	7M1016-8004
	 Grigio scuro Dark grey Gris foncté	8007		7M1008-8007	7M1012-8007	7M1016-8007
	 Beige Beige Beige	1008		7M1008-1008	7M1012-1008	7M1016-1008
	 Rosso Red Rouge	4027		7M1008-4027	7M1012-4027	7M1016-4027
	 Verde chiaro Light green Vert clair	7004		7M1008-7004	7M1012-7004	7M1016-7004
	 Blu Blue Bleu	6071		7M1008-6071	7M1012-6071	7M1016-6071

Copertura grigia / Grey cover
Couverture gris / Cobertura
gris / Graue Abdeckung

	<p>Copertura bianca White cover Couverture blanche Cobertura blanca Weisse Abdeckung</p> <p>Colore Colour</p>	75 cm	119 cm	159 cm
				
		Codice/Code Prezzo/Price	Codice/Code Prezzo/Price	Codice/Code Prezzo/Price
 <p>Copertura bianca / White cover Couverture blanche / Cobertura blanca / Weisse Abdeckung</p>	 <p>Bianco White Blanc</p> <p>0001</p>	7M1008BO-0001	7M1012BO-0001	7M1016BO-0001
	 <p>Grigio argento Silver grey Gris argenté</p> <p>8004</p>	7M1008BO-8004	7M1012BO-8004	7M1016BO-8004
	 <p>Grigio scuro Dark grey Gris foncté</p> <p>8007</p>	7M1008BO-8007	7M1012BO-8007	7M1016BO-8007
	 <p>Beige Beige Beige</p> <p>1008</p>	7M1008BO-1008	7M1012BO-1008	7M1016BO-1008
	 <p>Rosso Red Rouge</p> <p>4027</p>	7M1008BO-4027	7M1012BO-4027	7M1016BO-4027
	 <p>Verde chiaro Light green Vert clair</p> <p>7004</p>	7M1008BO-7004	7M1012BO-7004	7M1016BO-7004
	 <p>Blu Blue Bleu</p> <p>6071</p>	7M1008BO-6071	7M1012BO-6071	7M1016BO-6071

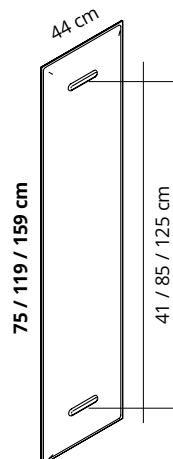

Pannello con imbottitura interna in poliester a **densità variabile** Snowsound® Technology. Rivestimento esterno in tessuto di poliester Trevira CS®.

Completo di attacchi in tecnopolimero e acciaio e coperture frontali in tecnopolimero grigio o bianco.

Il pannello può essere fissato direttamente a parete tramite viti (non incluse). Peso del singolo pannello 2,7 / 2,3 / 1,5 Kg.

Panel with polyester internal padding with Snowsound® Technology **variable density**. Polyester covering in Trevira CS® fabric.

Supplied with connections in high-tech polymer and steel and grey or white high-tech polymer front covers.

The panel can be directly fixed to the wall through screws (not included).

Weight of single panel: 2,7 / 2,3 / 1,5 kg

Panneau avec rembourrage interne en polyester à **densité variable** Snowsound® Technology. Revêtement externe en tissu de polyester Trevira CS®.

Avec jonctions en technopolymère et acier et couvertures frontales en technopolymère gris ou blanc. On peut fixer le panneau directement au mur par des vis (pas incluses). Poids d'un panneau: 2,7 / 2,3 / 1,5 kg

Panel con acolchado interior de poliéster de **densidad variable** Snowsound® Technology. Revestimiento exterior de tejido de poliéster Trevira CS®. Incluye enganches de polímero y acero y coberturas frontales de polímero gris o blanco. El panel puede ser fijado directamente a la pared por medio de tornillos (no incluydos). Peso para singulo panel 2,7 / 2,3 / 1,5 Kg.

Panel mit Polyester-Füllmaterial von **unterschiedlicher Dichte** Snowsound® Technology. Polyester-Bezug aus Trevira CS®-Material. Inklusive Beschlägen aus Technopolymer und Stahl sowie grauen oder weissen Befestigungsabdeckungen aus Technopolymer. Das Paneel kann mit Schrauben (nicht inkludiert) direkt an der Wand montiert werden.

Gewicht eines Paneels: 2,7 / 2,3 / 1,5 kg.



Montaggio semplice
a parete pannello
Mitesco
Basic wall mounting
for Mitesco panel



Dettaglio attacco e copertura frontale colore grigio.

Detail of the connection and front cover. Grey Color.

Détail jonction et couverture frontale, couleur gris.

Detalle ataque y cobertura frontal color gris.

Detaildarstellung der Befestigungsbeschläge und grauer Abdeckung



Dettaglio attacco e copertura frontale colore bianco.

Detail of the connection and front cover. White Color.

Détail jonction et couverture frontale, couleur blanc.

Detalle ataque y cobertura frontal color blanco.

Detaildarstellung der Befestigungsbeschläge und weisser Abdeckung

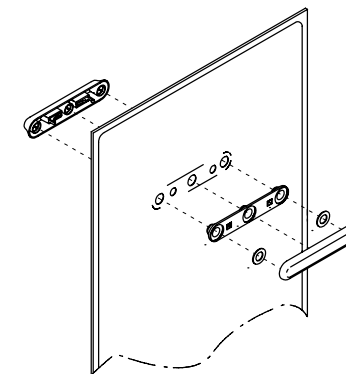

Dettaglio dell'attacco con copertura frontale forniti di serie in colore grigio o bianco.

Le coperture frontali sono disponibili anche colorate cod. 7M102-XXXX (XXXX = Variante colore).

Detail of the connection and front cover in standard grey or white. The front covers are also available in other colors with code 7M102-XXXX (XXXX = Color option).

Détail de la jonction avec couverture frontale, fournie standard en couleur gris ou blanc. Les couvertures frontales sont disponibles aussi dans d'autres couleurs avec réf. 7M102-XXXX (XXXX = option couleur).

Detalle ataque con cobertura frontal incluye en color gris o blanco. Las coberturas frontales son disponibles también en color cod. 7M102-XXXX (XXXX = Variante color).

Detaildarstellung der Befestigungsbeschläge mit standardmäßiger Abdeckung in grau oder weiss. Die Abdeckungen sind auch in anderen Farben erhältlich, Art. 7M102-XXXX (XXXX = Farbvariante).

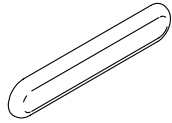

7M102-0001

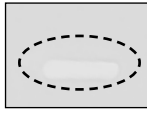

Bianco
White
Blanc
Weiss
Blanco

1 coppia / 1 pair
1 paire / 1 pare
1 Paar

7M102-4027

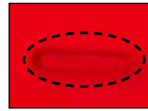

Rosso
Red
Rouge
Rojo
Rot

1 coppia / 1 pair
1 paire / 1 pare
1 Paar

Coppia di coperture frontali in tecnopolimero degli attacchi per 1 pannello Mitesco.

OPZIONALE

(Il pannello Mitesco è fornito di serie con le coperture frontali di colore grigio o bianco)

Pair of high-tech polymer front covers for connections for 1 panel Mitesco.

OPTIONAL

(Mitesco panels are supplied as standard with grey or white front covers)

Paire de couvertures frontales en technopolymère pour jonctions pour 1 panneau Mitesco.

OPTIONNEL

(Le panneau Mitesco est fourni en standard avec les couvertures frontales en couleur gris ou blanc)

Par de coberturas frontales de tecnopolimero para enganches de 1 panel Mitesco.

OPCIONAL

(el panel Mitesco ya incluye las coberturas frontales en color gris o blanco)

Paar Abdeckungen aus Technopolymer für Befestigung für 1 Paneel Mitesco.

OPTIONAL erhältlich

(Mitesco-Paneele werden standardmäßig mit grauen oder weissen Befestigungsabdeckungen geliefert).

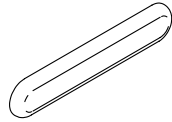

7M102-8004

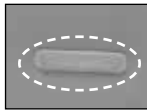

Grigio argento
Silver grey
Gris argenté
Gris plata
Silbergrau

1 coppia / 1 pair
1 paire / 1 pare
1 Paar

7M102-7004

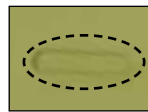

Verde chiaro
Light green
Vert clair
Verde claro
Hellgrün

1 coppia / 1 pair
1 paire / 1 pare
1 Paar

7M102-8007

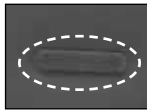

Grigio scuro
Dark grey
Gris foncé
Gris oscuro
Dunkelgrau

1 coppia / 1 pair
1 paire / 1 pare
1 Paar

7M102-6071

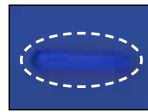

Blu
Blue
Bleu
Azul
Blau

1 coppia / 1 pair
1 paire / 1 pare
1 Paar

7M102-1008

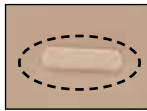

Beige
Beige
Beige
Beige
Beige

1 coppia / 1 pair
1 paire / 1 pare
1 Paar

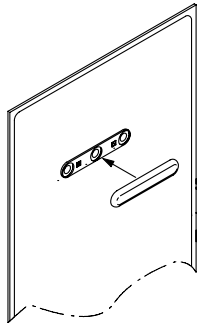

NOTA

Non utilizzare con staffe scrivania cod. 7M511-XX / 7M515-XX / 7M5100-XX / 7M519-XX / 7M518-XX / 7M517-XX (XX = Variante colore).

Not to be used with desk brackets code 7M511-XX / 7M515-XX / 7M5100-XX / 7M519-XX / 7M518-XX / 7M517-XX (XX = Color option).

Ne pas utiliser avec étriers pour bureau réf 7M511-XX / 7M515-XX / 7M5100-XX / 7M519-XX / 7M518-XX / 7M517-XX (XX = option couleur).

No utilizar con abrazaderas para mesa cod. 7M511-XX / 7M515-XX / 7M5100-XX / 7M519-XX / 7M518-XX / 7M517-XX (XX = Variante color).

Nicht zur Verwendung mit Halterungen für Tisch Art. 7M511-XX / 7M515-XX / 7M5100-XX / 7M519-XX / 7M518-XX / 7M517-XX (XX = Farbvariante).

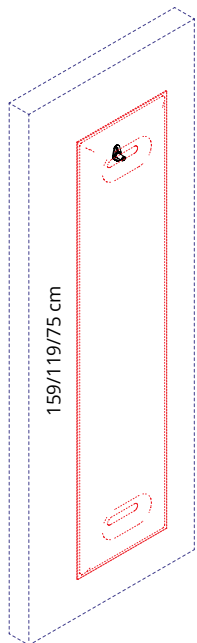

7M210-GR

Grigio
Grey
Gris
Gris
Grau

Aggancio semplice in tecnopolimero per fissaggio a parete tramite chiodo/vite (non inclusi) di un pannello Mitesco.

Easy connection in high-tech polymer for wall fixing by nail/screw (not included) of 1 Mitesco panel.

Accrochage simple en technopolymère pour fixation au mur par un clou/vis (pas inclus) d'un panneau Mitesco.

Enganche simple de polímero para fijación a pared por medio de clavo / tornillo (no incluido) de un panel Mitesco.

Einfache Befestigung aus Technopolymer für die Wandmontage mittels Nagel/Schraube (nicht inkludiert) eines Mitesco-Panels.

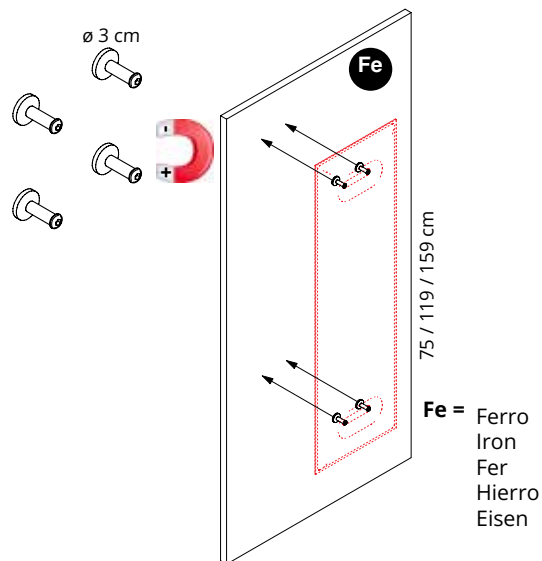

7M232

Kit 4 magneti per il fissaggio diretto ad una superficie verticale in ferro di un pannello Mitesco.

Set of 4 magnets for direct fixing to a vertical iron surface, of 1 Mitesco panel.

Jeu de 4 aimants pour la fixation directe à une surface verticale en fer d'un panneau Mitesco.

Kit de 4 imanes para la fijación directa a una superficie vertical de hierro de un panel Mitesco.

Set von 4 Magneten zur direkten Befestigung auf einer vertikal Eisenoberfläche, für 1 Mitesco-Paneel.



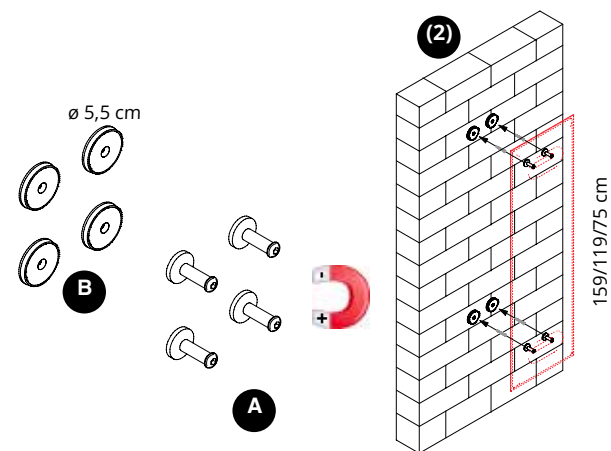
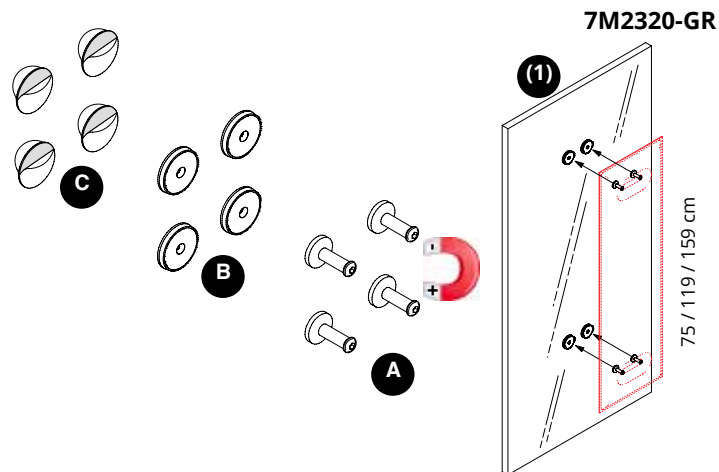

Kit per il fissaggio ad una superficie verticale in vetro o in muratura di un pannello Mitesco. Il kit è composto da: 4 magneti (A) / 4 dischi in acciaio e tecnopolimero grigio (B) / 4 dischi con biadesivo (C).

(1) Per le superfici in vetro applicare gli appositi dischetti con biadesivo (C).

(2) Per le superfici in muratura applicare direttamente i dischetti (B) tramite viti (non incluse)

Set for fixing to a glass or masonry vertical surface, of 1 Mitesco panel. Set composed of: 4 magnets (A) / 4 steel and high-tech polymer plates (B) / 4 plates with double-sided adhesive tape (C).

(1) For glass surfaces use the suitable plates with double-sided adhesive tape (C)

(2) For masonry surfaces fix directly the plates (B) with screws (not included)

Jeu pour fixation à une surface verticale en verre ou maçonnerie d'un panneau Mitesco. Le jeu se compose de: 4 aimants (A) / 4 disques en acier et technopolymère (B) / 4 disques avec bande biadhésive (C).

(1) Pour les surfaces en verre appliquer les disques par bande biadhésive (C)

(2) Pour les surfaces en maçonnerie appliquer directement les disques (B) par des vis (pas incluses)

Kit para fijación a una superficie vertical de vidrio o de mampostería de un panel Mitesco. Kit compuesto por: 4 imanes (A) / 4 discos de acero y polímero (B) / 4 discos con bi-adesivo (C).

(1) Para las superficies de vidrio aplicar los discos con su propio bi-adesivo (C)

(2) Para las superficies de mampostería aplicar directamente los discos (B) con tornillos (no incluidos)

Set zur Montage auf vertikal Glasoberflächen und Mauerwerk, für 1 Mitesco-Paneel. Set von: 4 Magneten (A) / 4 Scheiben aus Stahl und Technopolymer (B) / 4 doppelseitig klebende Scheiben (C).

(1) Für Glasoberflächen verwenden Sie die entsprechenden doppelseitig klebenden Scheiben (C)

(2) Für Mauerwerk befestigen Sie die Scheiben direkt (B) mit Schrauben (nicht inkludiert)

MAGNETIC



7M2320-GR



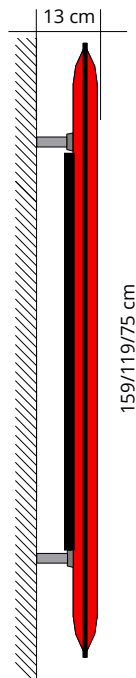
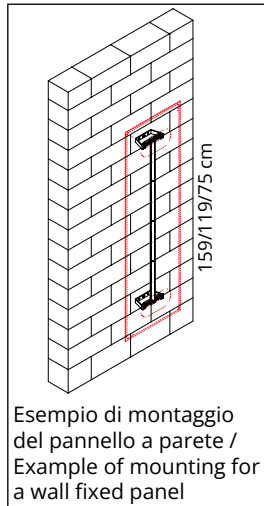
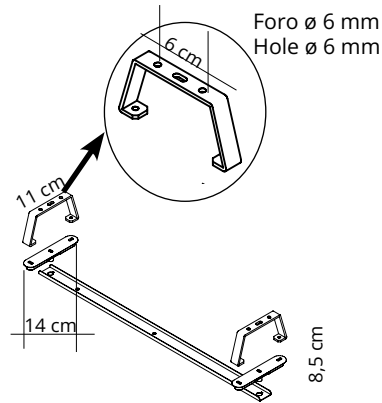

7M2478-GA Grigio argento
 Silver grey
 Gris argenté
 Gris plata
 Silbergrau

Per pannelli
For panels
L. 75 cm

Coppia attacchi distanziali in acciaio verniciato con polveri epossidiche e tecnopolimero per parete, completi di profilo livellatore per pannello Mitesco. Per montaggio a PARETE

7M2472-GA Grigio argento
 Silver grey
 Gris argenté
 Gris plata
 Silbergrau

Per pannelli
For panels
L. 119 cm

Pair of spacer connections in powder coated steel and high-tech polymer for wall, supplied with leveler profile for Mitesco panel. For WALL mounting

7M2476-GA Grigio argento
 Silver grey
 Gris argenté
 Gris plata
 Silbergrau

Per pannelli
For panels
L. 159 cm

Paire d'accrochages espaceurs en acier peint en époxy et technopolymère pour mur, avec un profil niveleur pour panneau Mitesco. Pour montage MURAL

Par de enganches espaciadores de acero recubierto epoxi y polímero para pared, incluye perfil nivelador para panel Mitesco. Para montaje en PARED

Paar Distanzhalterbefestigungen aus pulverbeschichtetem Stahl und Technopolymer zur Wandmontage, inkl. Justierungsprofil für Mitesco-Paneel. Für WANDMONTAGE

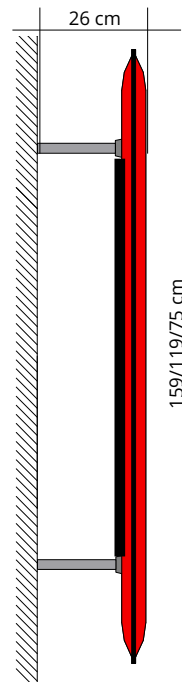
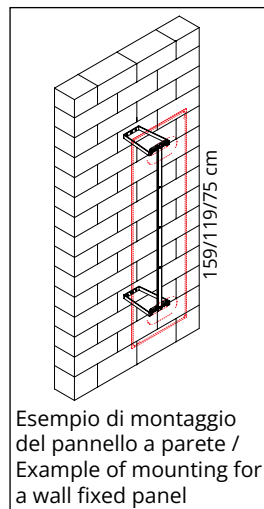
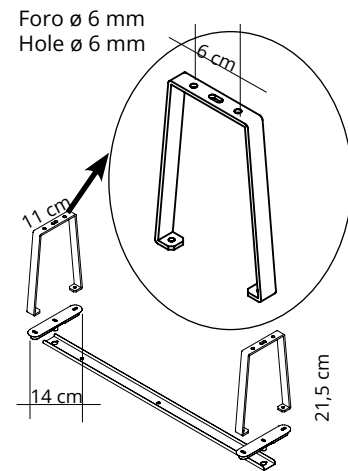

7M2428-GA Grigio argento
 Silver grey
 Gris argenté
 Gris plata
 Silbergrau

Per pannelli
For panels
L. 75 cm

Coppia attacchi distanziali in acciaio verniciato con polveri epossidiche e tecnopolimero per parete, completi di profilo livellatore per pannello Mitesco. Per montaggio a PARETE

7M2422-GA Grigio argento
 Silver grey
 Gris argenté
 Gris plata
 Silbergrau

Per pannelli
For panels
L. 119 cm

Pair of spacer connections in powder coated steel and high-tech polymer for wall, supplied with leveler profile for Mitesco panel. For WALL mounting

7M2426-GA Grigio argento
 Silver grey
 Gris argenté
 Gris plata
 Silbergrau

Per pannelli
For panels
L. 159 cm

Paire d'accrochages espaceurs en acier peint en époxy et technopolymère pour mur, avec un profil niveleur pour panneau Mitesco. Pour montage MURAL

Par de enganches espaciadores de acero recubierto epoxi y polímero para pared, incluye perfil nivelador para panel Mitesco. Para montaje en PARED

Paar Distanzhalterbefestigungen aus pulverbeschichtetem Stahl und Technopolymer zur Wandmontage, inkl. Justierungsprofil für Mitesco-Paneel. Für WANDMONTAGE





AKOESTIEKBOETIEK



Deze informatie is afkomstig van de website van AkoestiekBoetiek.nl.

Voor vragen, toelichting en meer informatie kunt u contact opnemen met:

AkoestiekBoetiek

Modem 20b

7741 MJ Coevorden

T +31 (0)85-077 3688

E info@akoestiekboetiek.nl

W www.akoestiekboetiek.nl