



INDUSTRIAL

AKOESTIEKBOETIEK



SPECIFICATION

Range: **INDUSTRIAL**
Design: **Caimi Lab**

Sound-absorbing element, fixed to the wall/ceiling or suspended from the ceiling with cables.

Panel description:

40 mm thick sound-absorbing panel, consisting of variable density polyester fibers, denser near the outside and softer on the inside. The panel is double sided, with same characteristics on both sides with rounded edges.

The panel has **Euroclass B-s2, d0** fire reaction.

The panel is **Greenguard Gold** certified, which validates its low VOC emission and its contribution to the quality of the indoor environment.

The panel is **100% recyclable** and it does not contain felts or other organic materials that are hardly recyclable.

The panel has been tested in reverberation chamber according to UNI EN ISO 354 and obtained "**Acoustic Absorption Class A**", in accordance with UNI EN ISO 11654.

Panel dimensions:

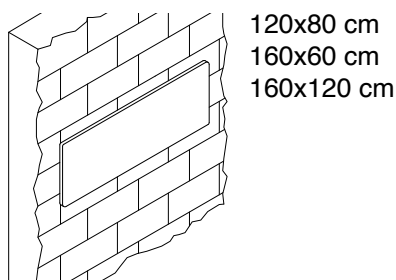
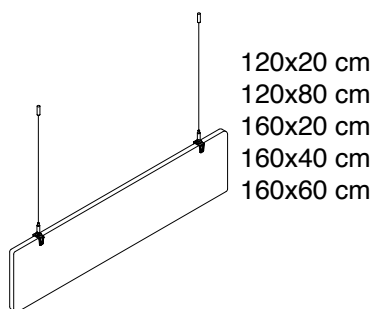
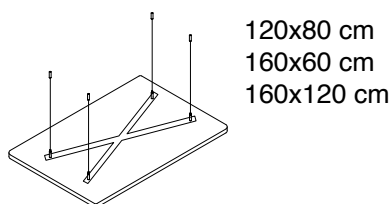
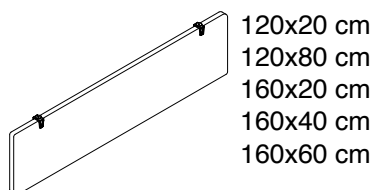

The products described in this data sheet are **CE marked** according to the harmonized product standard EN 13964 for the intended use as a drop ceiling.

INDUSTRIAL sound-absorbing panels meet the "CAM" Minimum Environmental Criteria.



Wall supports description:

Wall fixings, each consisting of a galvanised steel plate and two technopolymer spacers. These components are fixed on the back of the panel by means of self-tapping screws and the plate has a notched slot to be fixed to the wall by nails or screws. All panels need 2 fixings.

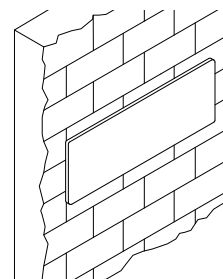
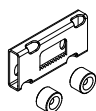

Ceiling supports description:

Ceiling fixing, consisting of two 'C' shaped supports that embrace the panel along its thickness. Each support, made of nickel-plated zamak, is fixed to the panel by means of 2 self-tapping screws and is attached to the ceiling by means of dedicated screws.

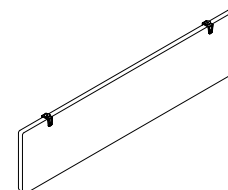

Ceiling supports description with cables:

Ceiling fixings, consisting of 2 galvanised steel cables leaded at one end. Each cable is hooked in the upper part to two turned and galvanised metal elements that allow the cable to be held by its leaded end and fixed to the ceiling by means of a single screw. In the lower part, each cable is held by a height adjustment and cable locking element, made of turned and galvanised metal screwed, which is screwed using an M6x16 screw to a "C" shaped support that embraces the panel along its thickness. Each support is made of nickel-plated zamak and fixed to the panel with 2 self-tapping screws.

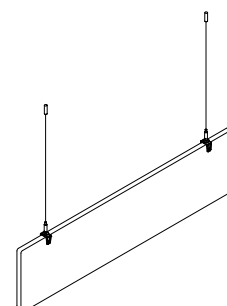

Structure and ceiling fixing description with cables:

Ceiling fixing, consisting of 4 galvanised steel cables leaded at one end. Each cable is hooked in the upper part to two turned and galvanised metal elements that allow the cable to be held by its leaded end and fixed to the ceiling by means of a single screw. In the lower part, each cable is held by a height adjustment and cable locking element, made of turned and galvanised metal screwed to a metal element for direct fixing to the sound-absorbing panel by means of self-tapping screws. The frame consisting of 2 elements made of galvanised steel tubular with a rectangular section, one 40x15 mm and the other 40x10 mm, thickness 1.2 mm. The elements are inserted into each other at the centre by means of dedicated through-holes that also allow for dimensional adjustment.

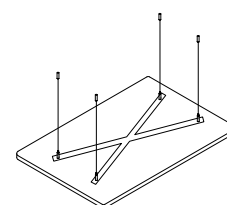

Available colours:



SPECIFICATION

Range: **INDUSTRIAL**
Design: **Caimi Lab**

Sound-absorbing element, fixed to the wall or ceiling.

Panel description:

40 mm thick sound-absorbing panel, consisting of variable density polyester fibers, denser near the outside and softer on the inside. The panel is double sided, with same characteristics on both sides with rounded edges.

The panel is equipped with 6 \varnothing 20 mm holes that allow the insertion of wall/ceiling supports.

The panel has **Euroclass B-s2, d0** fire reaction.

The panel is **Greenguard Gold** certified, which validates its low VOC emission and its contribution to the quality of the indoor environment.

The panel is **100% recyclable** and it does not contain felts or other organic materials that are hardly recyclable.

The panel has been tested in reverberation chamber according to UNI EN ISO 354 and obtained "**Acoustic Absorption Class A**", in accordance with UNI EN ISO 11654.

Panel dimension: 160x120 cm

Wall/ceiling fixing description:

Fixing kit consisting of 6 cylindrical supports with \varnothing 20 mm through-hole made of zamak. At the front they have a \varnothing 40 mm flange that allows the supports to lock onto the panel. The wall-fixing screws, not supplied, are inserted through the through-hole (max. screw head \varnothing 16 mm)..

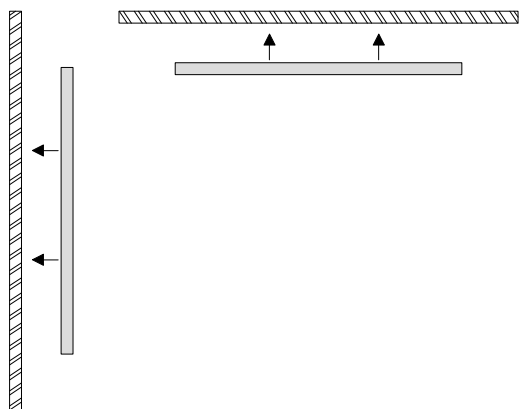

The products described in this data sheet are **CE marked** according to the harmonized product standard EN 13964 for the intended use as a drop ceiling.

The products described in this data sheet are specifically designed for use in gyms (DIN 18032-3:2023 and UNI EN 13964:2014).

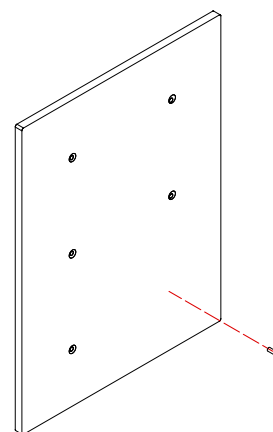

Available colours:

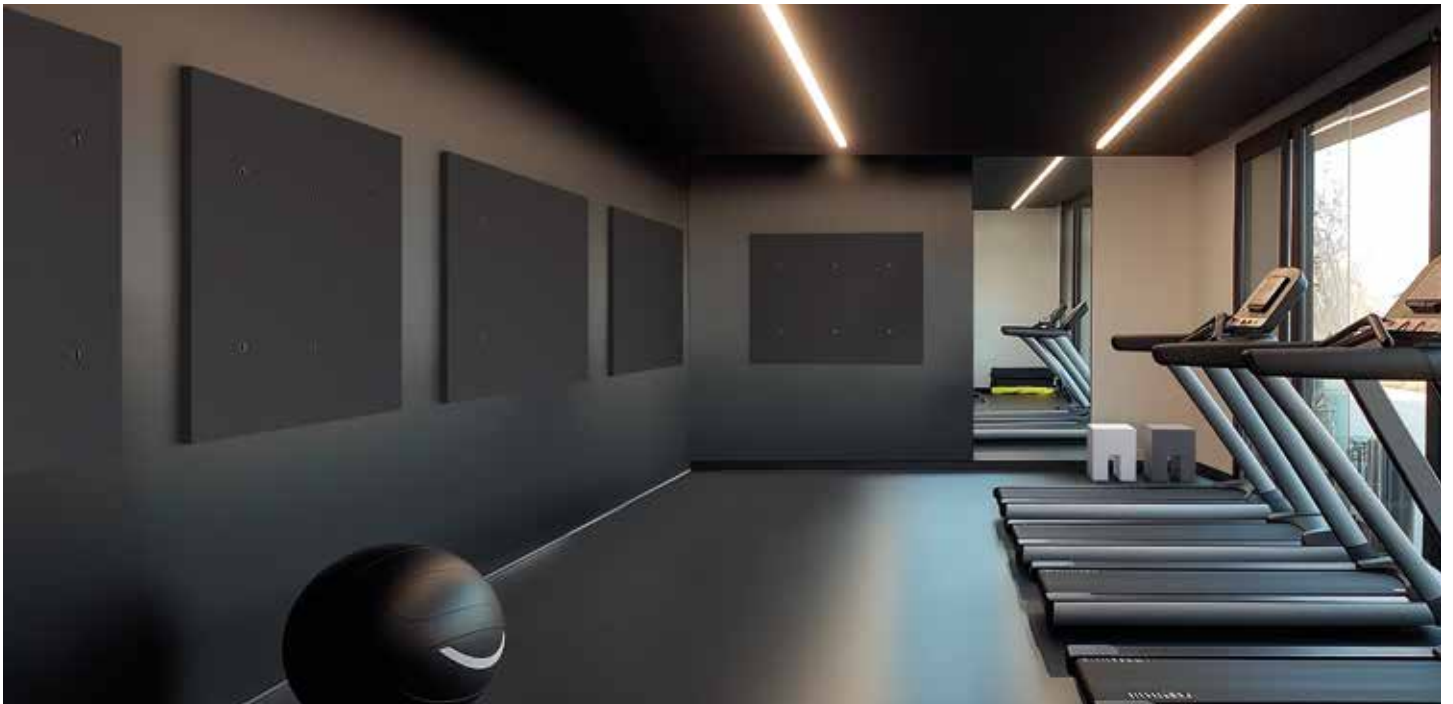

Caimi Brevetti S.p.A. reserves, by its unappealable judgment, the right to modify without prior notice the building materials, the technical and aesthetic specifications, as well as the dimensions of the products in this technical sheet, where pictures are purely as an indication.



AKOESTIEKBOETIEK



Deze informatie is afkomstig van de website van AkoestiekBoetiek.nl.

Voor vragen, toelichting en meer informatie kunt u contact opnemen met:

AkoestiekBoetiek

Modem 20b

7741 MJ Coevorden

T +31 (0)85-077 3688

E info@akoestiekboetiek.nl

W www.akoestiekboetiek.nl